



Art.-Nr. 1 44480 0
MB 110

DE

STAHL-ARBEITSBOCK

Montage-, Bedienungs- und Sicherheitshinweise

FR

TRÉTEAU EN MÉTAL

Instructions d'utilisation et consignes de sécurité

IT

CAVALLETTO IN ACCIAIO

Indicazioni per l'uso e per la sicurezza

DK

STÅL-ARBEJDSBUK

Brugs- og sikkerhedsanvisninger

GB

STEEL TRESTLE

Assembly, operating and safety instructions

NL

STALEN SCHRAAG

Bedienings- en veiligheidsinstructies

PL

STALOWY KOZIOŁ ROBOCZY

Wskazówki dotyczące obsługi i bezpieczeństwa





DE	Bedienungs- und Sicherheitshinweise	Seite	5
GB	Operation and Safety Notes	Page	11
FR	Instructions d'utilisation et consignes de sécurité	Page	17
NL	Bedienings- en veiligheidsinstructies	Pagina	23
IT	Indicazioni per l'uso e per la sicurezza	Pagina	29
PL	Wskazówki dotyczące obsługi i bezpieczeństwa	Strona	35
DK	Brugs- og sikkerhedsanvisninger	Side	41







A





B

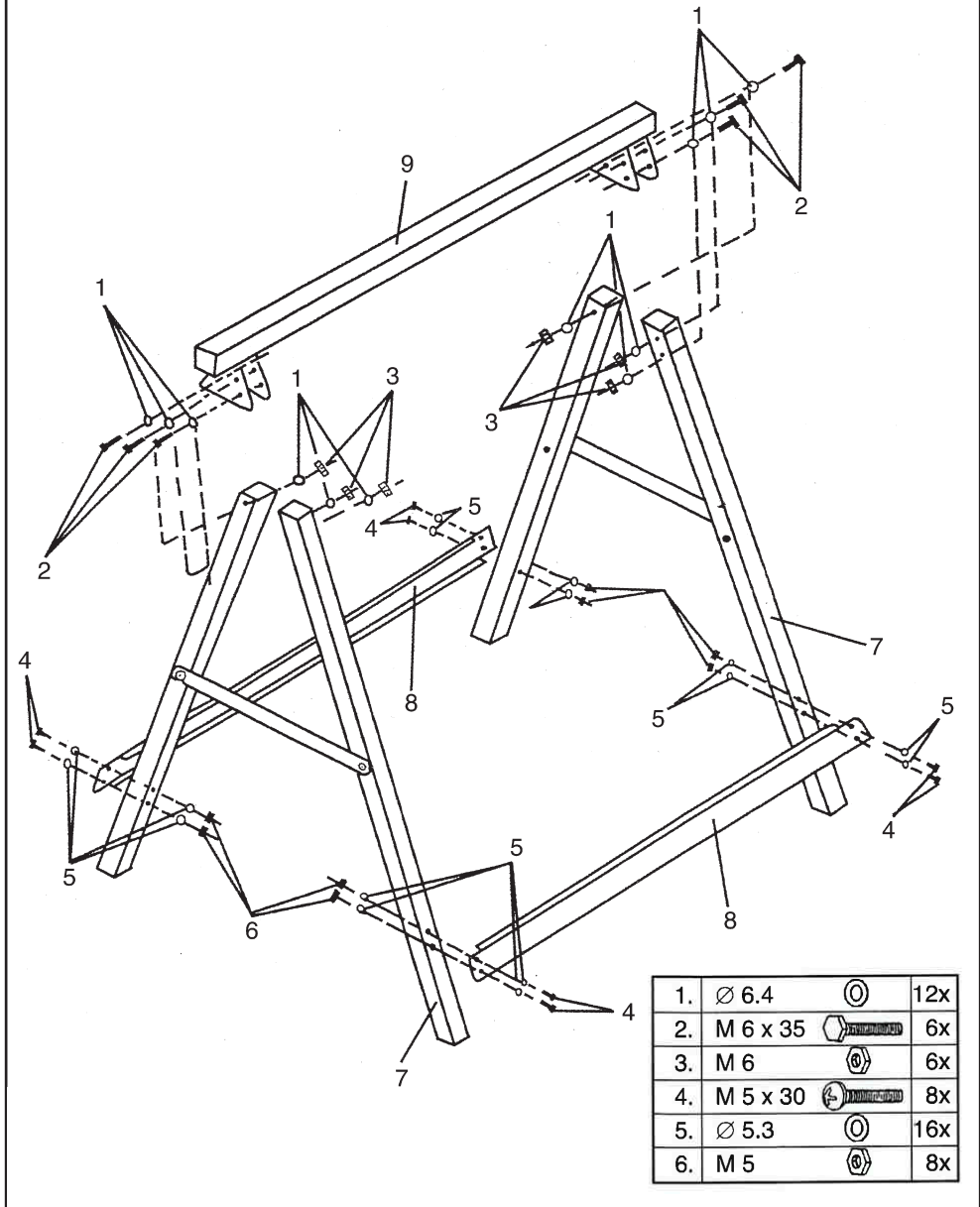

1.	∅ 6.4		12x
2.	M 6 x 35		6x
3.	M 6		6x
4.	M 5 x 30		8x
5.	∅ 5.3		16x
6.	M 5		8x





In dieser Bedienungsanleitung / am Gerät werden folgende Piktogramme verwendet.....Seite 6

Einleitung.....Seite 6

 Bestimmungsgemäßer Gebrauch.....Seite 6

 Lieferumfang.....Seite 7

 Teilebeschreibung.....Seite 7

 Technische Daten.....Seite 7

Sicherheitshinweise.....Seite 7

Montage.....Seite 8

Verwendung.....Seite 8















Reparatur, Wartung und Lagerung.....Seite 8

Entsorgung.....Seite 9

Informationen.....Seite 9

 Garantieerklärung.....Seite 9

 Hersteller / Service.....Seite 9

In dieser Bedienungsanleitung / am Gerät werden folgende Piktogramme verwendet:			
	Bedienungsanleitung lesen!		Achten Sie darauf, dass der Arbeitsbock sicher steht und nicht umkippen kann.
	Warn- und Sicherheitshinweise beachten!		Benutzen Sie das Produkt nur auf festen, ebenen Flächen.
	Lebens- und Unfallgefahr für Kleinkinder und Kinder!		Verwenden Sie den Arbeitsbock keinesfalls auf Untergründen mit Gefälle
	Verwenden Sie den Arbeitsbock niemals als Leiter o.ä.		Achten Sie darauf, dass die Standbeine komplett auseinandergeklappt und die Spreizsicherungen angebracht sind, wenn Sie den Arbeitsbock verwenden.
	Diesen Arbeitsbock nicht als Gerüstbock verwenden.		Achten Sie darauf, dass der Untergrund weder feucht noch ölig ist.
	Achten Sie darauf, dass Sie die zulässige Tragkraft von 110 kg niemals überschreiten.		Sichern Sie die Arbeitsplatte gegen Verrutschen.
	Belasten Sie das Werkstück nicht einseitig.		Überprüfung der Sicherungs- oder Verstelleinrichtung.
	Bei Beschädigung den Arbeitsbock nicht mehr benutzen.		

Stahl-Arbeitsbock MB 110

● Einleitung



Machen Sie sich vor dem ersten Gebrauch mit dem Produkt vertraut. Lesen Sie die Bedienungsanleitung und die Sicherheitshinweise aufmerksam durch. Bewahren Sie die Bedienungsanleitung sorgfältig auf. Händigen Sie bei Weitergabe des Produkts an Dritte alle Unterlagen mit aus. Verwenden Sie das Produkt nur wie beschrieben und für die angegebenen Einsatzbereiche.

○ Bestimmungsgemäßer Gebrauch

Der Arbeitsbock ist als Tapeziertisch o.ä. für den Heimwerker- und Hobbygebrauch vorgesehen. Es ist nicht zulässig, auf den Arbeitsbock oder die Arbeitsplatte zu steigen. Andere Verwendungen oder Veränderungen des Produkts gelten als nicht bestimmungsgemäß und bergen erhebliche Unfallgefahren. Für Schäden, die aus bestimmungswidrigem Gebrauch entstanden sind, übernimmt der Hersteller keine Haftung. Das Produkt ist nicht für den gewerblichen Einsatz bestimmt.

○ Lieferumfang

- 1 x Stahl-Arbeitsbock
- 1 x Bedienungsanleitung

○ Teilebeschreibung

Sehen Sie dazu die Abbildung „A“.



- 1 Auflagefläche
- 2 Standbeine
- 3 Spreizsicherung

○ Technische Daten









Typ: MB 110
 Maße (ausgeklappt): 63 x 71 cm
 Gewicht: 3 kg
 Max. Tragfähigkeit: 110 kg





Sicherheitshinweise

BEWAHREN SIE ALLE SICHERHEITSHINWEISE UND ANWEISUNGEN SORGFÄLTIG AUF!

-  **⚠️ WARNUNG! LEBENS- UND UNFALLGEFAHR FÜR KLEINKINDER UND KINDER!** Lassen Sie Kinder niemals unbeaufsichtigt mit Verpackungsmaterial. Es besteht Erstickenungsgefahr durch Verpackungsmaterial. Kinder unterschätzen häufig die Gefahren. Halten Sie Kinder stets vom Produkt fern. Der Arbeitsbock ist kein Spielzeug.
-  Prüfen Sie den Arbeitsbock nach Lieferung und vor jeder Benutzung, um den Zustand und die Funktion aller

Teile festzustellen. Verwenden Sie das Produkt keinesfalls wenn es beschädigt ist. Andernfalls droht Verletzungsgefahr.

- Verwenden Sie keinen beschädigten Arbeitsbock.
-  **VORSICHT!** Lassen Sie Kinder nicht unbeaufsichtigt! Das Produkt ist kein Kletter- oder Spielgerät! Stellen Sie sicher, dass Personen, insbesondere Kinder nicht auf das Produkt klettern bzw. sich nicht am Produkt anlehnen. Das Produkt könnte aus dem Gleichgewicht kommen und umkippen. Verletzungen und/oder Beschädigungen können die Folgen sein.
-  **VORSICHT! VERLETZUNGS-GEFAHR!** Verwenden Sie den Arbeitsbock niemals als Leiter o.ä.
-  **VORSICHT! VERLETZUNGS-GEFAHR!** Besteigen Sie niemals den Arbeitsbock oder die Arbeitsplatte.
-  Achten Sie darauf, dass Sie die zulässige Tragkraft von 110 kg niemals überschreiten.
-  Achten Sie darauf, dass der Arbeitsbock sicher steht und nicht umkippen kann. Verletzungen und/oder Beschädigungen des Produkts können die Folgen sein.
-  **VORSICHT! QUETSCHGEFAHR!** Achten Sie beim Auf- und Zuklappen des Arbeitsbocks auf Ihre Finger.
-  Benutzen Sie das Produkt nur auf festen, ebenen Flächen. Auf nicht befestigten und unebenen Flächen – wie z. B. Schotterdecken – kann es zum Verrutschen der Last kommen.
-  **VORSICHT! VERLETZUNGS-GEFAHR!** Verwenden Sie den Arbeitsbock keinesfalls auf Untergründen mit Gefälle. Der Arbeitsbock sowie evt. aufliegende Werkstücke können umkippen.

-  Achten Sie darauf, dass die Standbeine **2** komplett auseinandergeklappt und die Spreizsicherungen **3** angelegt sind, wenn Sie den Arbeitsbock verwenden. Nur so ist ein sicherer Stand gewährleistet.
-  Bei beschädigter Sicherungseinrichtung oder Schweißnaht den Arbeitsbock nicht mehr verwenden.
-  **VORSICHT! VERLETZUNGS-FAHR!** Achten Sie darauf, dass der Untergrund weder feucht noch ölig ist. Der Arbeitsbock kann wegrutschen und umfallen.
-  Achten Sie darauf, dass die Werkstücke / Arbeitsplatte auf der Auflagefläche **1** nicht verrutschen können / kann. Sichern Sie diese ggf.
-  Achten Sie darauf, dass Sie Werkstücke nicht einseitig belasten. Andernfalls kann das Werkstück aus dem Gleichgewicht kommen und herunterfallen.
- Beseitigen Sie alle Verunreinigungen, z. B. nasse Farbe, Schmutz, Öl oder Schnee, am Arbeitsbock.

● Montage

- Bauen Sie den Stahl-Arbeitsbock gemäß Zeichnung „B“ zusammen.

● Verwendung

Die Aufstellhinweise beziehen sich auf die Abbildung „A“.

- Klappen Sie die Standbeine **2** komplett auseinander.

-  **VORSICHT! VERLETZUNGS-FAHR!** Achten Sie darauf, dass die Spreizsicherungen **3** angelegt sind. Nur so ist ein sicherer Stand gewährleistet.

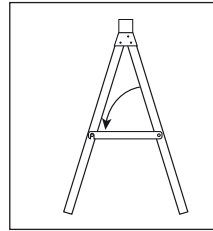

- Überprüfen Sie die Sicherungseinrichtungen auf korrekten Sitz.
- Legen Sie das zu bearbeitende Werkstück auf die Auflagefläche **1**.
- Hinweis:** Verwenden Sie für lange Werkstücke 2 Arbeitsböcke.
- ⚠ **VORSICHT!** Achten Sie darauf, dass die Werkstücke auf der Auflagefläche **1** nicht verrutschen.
- Klappen Sie die Standbeine **2** wieder zusammen, wenn Sie den Arbeitsbock nicht mehr benötigen.

● Reparatur, Wartung und Lagerung

- Lassen Sie Reparaturen und Wartungsarbeiten am Arbeitsbock von einer sachkundigen Person durchführen.
- Lagern Sie den Arbeitsbock in einem trockenen, geschlossenen Raum, wenn Sie ihn längere Zeit nicht verwenden.

● Entsorgung

Die Verpackung und das Verpackungsmaterial bestehen ausschließlich aus umweltfreundlichen Materialien. Sie können in den örtlichen Recyclingbehältern entsorgt werden.

Derzeit gültige Entsorgungsmaßnahmen für das ausgediente Produkt erfragen Sie bitte bei Ihrer Gemeinde- oder Stadtverwaltung.

● Informationen

○ Garantieerklärung

Sie erhalten auf dieses Gerät 2 Jahre Garantie ab Kaufdatum. Dies gilt nur gegenüber dem Ersteinkäufer und ist nicht übertragbar. Bitte bewahren Sie den Kassenbon als Nachweis auf. Die Garantieleistung bezieht sich nur auf Material- oder Fabrikationsfehler und gilt nicht für Verschleißteile oder für Beschädigungen durch unsachgemäßen Gebrauch. Bei Fremdverschulden erlischt die Garantie.

Ihre gesetzlichen Rechte werden durch diese Garantie nicht eingeschränkt.

Bitte setzen Sie sich im Garantiefall telefonisch mit der Servicestelle in Verbindung. Nur so kann eine kostenlose Einsendung Ihres Geräts gewährleistet werden.

○ Hersteller/Service

Hugo Brennenstuhl GmbH & Co. KG

Seestraße 1-3 · D-72074 Tübingen

H. Brennenstuhl S.A.S.

4 rue de Bruxelles · F-67170 Bernolsheim

lectra-t ag

Blegistrasse 13 · CH-6340 Baar

Für weitere Informationen empfehlen wir den Bereich Service/FAQ´s auf unserer Homepage www.brennenstuhl.com





The following pictograms are used in these operating instructions / on the device.....Page 12

Introduction.....Page 12

 Intended UsePage 12

 Scope of Delivery.....Page 12

 Description of parts.....Page 13

 Technical DataPage 13

Safety advicePage 13

Assembly.....Page 14

Use.....Page 14















Repair, Maintenance and StoragePage 14

Disposal.....Page 14

Information.....Page 14

 GuaranteePage 14

 Manufacturer / ServicePage 15

The following pictograms are used in these operating instructions / on the device:			
	Read instruction manual!		Make sure that the workbench is stable and cannot tip.
	Observe caution and safety notes!		Only use the product on firm, level surfaces.
	Danger of loss of life and accident to infants and children!		Never use the trestle on slopes
	Never use the workbench as a ladder or as anything else.		Be sure the legs are folded apart all the way and the leg locks are secured in place when using the trestle.
	Do not use the trestle as a scaffold trestle.		Make sure that the subsurface is not damp or oily.
	Make sure that you never exceed the maximum permissible load of 110 kg.		Secure the working surface so that it cannot slip.
	Do not load the workpiece unevenly, e.g. on one side only.		Checking the locking or adjustments.
	Discontinue using the trestle if damaged.		

Steel trestle MB 110

● Introduction



Before using the product for the first time, take time to familiarise yourself with the product first. Read the following operating instructions and safety instructions carefully. Please keep these instructions in a safe place. If you hand this product on to a third party, you must also pass on all documents relating to the product. Only use the product as described and for the designated areas of application.

○ Intended Use

This workbench is intended for use as a trestle table for DIY enthusiasts and hobbyist. Do not climb on the workbench or the work surface. Any use other than previously mentioned or any product modification is prohibited and can lead to injuries and/or product damage. The manufacturer is not liable for any damages caused by any use other than for the intended purpose. The product is not intended for commercial use.

○ Scope of Delivery

- 1 x steel trestle
- 1 x operating instructions

○ Description of parts

See figure „A“.

- 1 Top
- 2 Legs
- 3 Leg lock

○ Technical Data

Type: MB 110
 Dimensions: 63 x 71 cm
 Weight: 3 kg
 Max. Load: 110 kg





Safety advice

KEEP ALL SAFETY NOTICES AND INSTRUCTIONS IN A SAFE LOCATION!

- 

⚠ WARNING! DANGER OF LOSS OF LIFE AND ACCIDENT TO INFANTS AND CHILDREN!

Never leave children unsupervised with the packaging materials. The packaging material presents a suffocation risk. Children frequently underestimate danger. Keep out of reach of children. This work bench is not a toy.
- 

On delivery and prior to every use, inspect the work bench in order to check the condition and function of all parts. Do not use the product if it has been damaged. You risk injury if you do otherwise.
- Do not use a damaged workbench.
- 

CAUTION! Do not leave children unattended. The product is not a climbing frame or toy. Make sure that no-

body climbs or leans on the product, particularly children. The product could become imbalanced and tip up. This may result in injury and/or damage.

- 

CAUTION! RISK OF INJURY!
 Never use the workbench as a ladder or as anything else.
- 

CAUTION! RISK OF INJURY!
 Never climb on the workbench or work surface.
- 

Make sure that you never exceed the maximum permissible load of 110 kg.
- 

Make sure that the workbench is stable and cannot tip. Injuries or damage to the product can result.
- 

CAUTION! CRUSHING HAZARD!
 Watch your fingers when opening and closing the workbench.
- 



Only use the product on firm, level surfaces. If used on unstable or uneven surfaces – e.g. gravel surfaces – the load can slip.
- 

CAUTION! RISK OF INJURY!
 Absolutely do not use the workbench on subsurfaces that have slopes. The workbench, along with any workpieces on it, can tip over.
- 

Be sure the legs **2** are folded apart all the way and the leg locks **3** are secured in place when using the trestle. This will ensure stability.
- 

Discontinue using the trestle if the safety device or weld are damaged.
- 

CAUTION! RISK OF INJURY!
 Make sure that the subsurface is not damp or oily. The workbench can slip and fall over.

-  Verify the work pieces/sheet will not move on the top **1**. If necessary, secure in place.
-  Make sure that you do not load workpieces unevenly. Otherwise, the workpiece can become unbalanced and fall down.
- Remove any excess materials on the workbench, e.g. wet paint, dirt, oil or snow.

● Assembly

- Assemble the steel trestle as shown in illustration „B“.

● Use

The set-up notices apply to figure „A“.

- Fold the legs **2** all the way apart.
-  **CAUTION! RISK OF INJURY!** Be sure the leg locks **3** are secured in place. This will ensure stability.

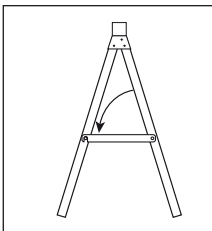

- Verify the safety devices are positioned correctly.
- Place the work piece you will be working on on the top **1**.

Note: Use 2 trestles when working on long work pieces.

- ▲ **CAUTION!** Ensure the work pieces will not move on the top **1**.
- Push the legs **2** together again when you are finished using the trestle.

● Repair, Maintenance and Storage

- Repairs and maintenance to the trestle should be performed by a competent person.
- Store the workbench in a dry, closed room if you are not going to use it for a protracted period.

● Disposal

The packaging is made entirely of recyclable materials, which you may dispose of at your local recycling facilities.

Details of current options for disposing of electrical appliances after their useful life can be obtained from your local or city council.

● Information

○ Guarantee

This device is guaranteed for 2 years from the purchase date. This applies only to the initial purchaser and is not transferrable. Please keep the receipt as documentation. The guarantee applies only to material or manufacturing defects and does not apply to regular wear or damage caused by improper use. In the case of third party culpability, the guarantee is void.

Your legal rights are not restricted by this guarantee. If you wish make a guarantee claim, contact our service office by telephone. This is the only way we can insure that you can send your device to us free of charge.

○ **Manufacturer / Service**

Hugo Brennenstuhl GmbH & Co. KG

Seestraße 1-3 · D-72074 Tübingen

H. Brennenstuhl S.A.S.

4 rue de Bruxelles · F-67170 Bernolsheim















lectra-t ag

Blegistrasse 13 · CH-6340 Baar

For further information please see our Service/FAQ section at www.brennenstuhl.com



Les pictogrammes suivants sont utilisés dans ce mode d'emploi / appliqués sur l'appareil	Page 18
Introduction	Page 18
Utilisation conventionnelle.....	Page 18
Étendue de la livraison.....	Page 19
Descriptif des pièces.....	Page 19
Données techniques.....	Page 19
Consignes de sécurité	Page 19
Montage	Page 20
Utilisation	Page 20
Réparation, maintenance et stockage	Page 20
Mise au rebut	Page 20
Informations	Page 21
Déclaration de garantie.....	Page 21
Fabricant / Service après-vente.....	Page 21

Les pictogrammes suivants sont utilisés dans ce mode d'emploi / appliqués sur l'appareil :			
	Lire le mode d'emploi !		Veiller à la position sûre du chevalet et prévenir tout basculement.
	Respecter les avertissements et les consignes de sécurité !		N'utiliser le produit que sur des surfaces solides et planes.
	Danger de mort et d'accident pour les enfants en bas âge et les enfants !		N'utilisez jamais le tréteau sur des sols en pente.
	Ne jamais utiliser le chevalet comme échelle etc.		Assurez-vous que les pieds soient complètement dépliés et que les protections contre l'écartement soient installées lors de l'utilisation du tréteau.
	N'utilisez pas ce tréteau comme un échafaudage.		Veiller à ce que le sol ne soit ni humide ni huileux.
	Veiller à ne jamais excéder la limite de charge admissible de 110 kg.		Bloquez le plan de travail afin qu'il ne puisse glisser.
	Ne chargez pas la pièce de manière unilatérale.		Vérifiez le dispositif de fixation ou de réglage.
	N'utilisez plus le tréteau en cas de dommage.		

Tréteau en métal MB 110

● Introduction



Familiarisez-vous avec le produit avant la première utilisation. Pour ce faire, lisez attentivement le mode d'emploi et les instructions de sécurité. Veuillez soigneusement conserver cette notice. Remettez tous les documents lors de la cession du produit à une tierce personne. N'utilisez le produit que pour l'usage décrit et que pour les domaines d'application cités.

○ Utilisation conventionnelle

Ce chevalet est prévu pour l'usage dans le domaine bricolage et hobby comme table de colleur ou à des fins pareilles. Il n'est pas admissible de monter sur le chevalet ou la plaque de travail.

Une autre utilisation que celle décrite ci-dessus ou une modification du produit n'est pas permise et peut mener à des blessures et/ou à un endommagement du produit. Le fabricant n'assume aucune responsabilité pour les dommages causés suite à une utilisation contraire à celle décrite. Le produit n'est pas destiné à l'utilisation professionnelle.

○ Étendue de la livraison

- 1 x Tréteau en métal
- 1 x Notice d'utilisation

○ Descriptif des pièces

Voir l'illustration „A“.

- 1** Surface du support
- 2** Pieds
- 3** Protection contre l'écartement

○ Données techniques









Type :	MB 110
Dimensions (pieds dépliés) :	63 x 71 cm
Poids :	3 kg
Limite de charge :	110 kg

Consignes de sécurité





CONSERVEZ SOIGNEUSEMENT TOUTES LES CONSIGNES DE SÉCURITÉ ET INSTRUCTIONS !

-  **AVERTISSEMENT ! DANGER DE MORT ET D'ACCIDENT POUR LES ENFANTS EN BAS ÂGE ET LES ENFANTS !** Ne jamais laisser les enfants manipuler sans surveillance le matériel d'emballage. Risque d'asphyxie par le matériel d'emballage. Les enfants sous-estiment souvent les dangers. Tenir les enfants toujours à l'écart du produit. Le chevalet n'est pas un jouet.
-  Après livraison et avant la première utilisation du tréteau, vérifiez le produit afin de constater l'état et le fonctionne-

ment de toutes les pièces. N'utilisez jamais le produit s'il est endommagé. Autrement, il existe un risque de blessures.

- Ne pas utiliser un chevalet endommagé.
-  **ATTENTION !** Ne laissez pas des enfants sans surveillance ! Le produit n'est pas un appareil d'escalade ou un jouet ! Veuillez vous assurer que personne, et surtout des enfants, n'escaladent ou ne s'appuient sur le produit. Le produit pourrait être déséquilibré et tomber. Ceci risque d'engendrer des blessures et/ou des dommages matériels.
-  **ATTENTION ! RISQUE DE BLESSURES !** Ne jamais utiliser le chevalet comme échelle etc.
-  **ATTENTION ! RISQUE DE BLESSURES !** Ne jamais monter sur le chevalet ou la plaque de travail.
-  **Max. 110kg** Veillez à ne jamais excéder la limite de charge admissible de 110 kg.
-  Veillez à la position sûre du chevalet et prévenir tout basculement. Des blessures et/ou des endommagements du produits pourraient en résulter.
-  **ATTENTION ! RISQUE DE CONTUSIONS !** En ouvrant et repliant le chevalet faire attention aux doigts.
-  N'utiliser le produit que sur des surfaces solides et planes. Les surfaces non fixées ou bien inégales – telles que p.ex. couches de grave – pourront provoquer le déplacement de la charge.
-  **ATTENTION ! RISQUE DE BLESSURES !** Ne jamais utiliser le chevalet sur une base oblique. Le chevalet ainsi que des pièces se trouvant sur celui pourront basculer.
-  Veillez à ce que les pieds **2** soient complètement dépliés, et à installer les protections contre l'écartement **3**

lorsque vous utilisez le produit. De cette manière seulement, un maintien sûr du produit est garanti.

-  En cas de dispositif de sécurité endommagé ou de joint de soudure, ne plus utiliser le tréteau.
-  **ATTENTION ! RISQUE DE BLESSURES !** Veiller à ce que le sol ne soit ni humide ni huileux. Le chevalet pourrait se déplacer et basculer.
-  Veillez à ce que les pièces / le plateau de travail ne puisse(nt) pas glisser de la surface du support **1**. Les sécuriser le cas échéant.
-  Veiller à ne pas charger les pièces unilatéralement. Sinon, la pièce pourrait perdre l'équilibre et tomber par terre.
- Libérer le chevalet de toute matière telle que peinture humide, saleté, huile ou neige.

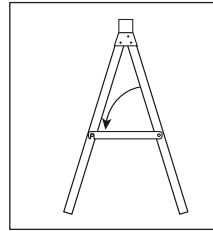

- Vérifiez la bonne installation des dispositifs de sécurité et de réglage.
 - Placez la pièce à travailler sur la surface du support **1**.
- Remarque :** Utilisez 2 tréteaux pour les longues pièces à travailler.
- ⚠ ATTENTION !** Veillez à ce que les pièces à usiner ne puissent pas glisser sur la surface de support **1**.
- Repliez les pieds **2** lorsque vous n'avez plus besoin du tréteau.

● Montage

- Assemblez le tréteau en métal selon l'illustration „B“.

● Utilisation

Les instructions d'installations se réfèrent à l'illustration „A“.

- Dépliez toujours complètement les pieds **2**.
 -  **ATTENTION ! RISQUE DE BLESSURES !** Veillez à installer les protections contre l'écartement **3**.
- De cette manière seulement, un maintien sûr du produit est garanti.

● Réparation, maintenance et stockage

- Ne confiez les réparations ou les travaux de maintenance sur le tréteau qu'à des spécialistes.
- Conserver le chevalet dans un local sec et fermé lorsque vous ne l'utiliserez pas pour une longue période de temps.

● Mise au rebut

L'emballage et le matériel d'emballage se composent exclusivement de matières recyclables. Vous pouvez les mettre au rebut dans les conteurs locaux.

Renseignez-vous auprès de votre mairie ou de l'administration municipale des mesures de recyclage

actuellement applicables pour les appareils électriques usés.

● Informations

○ Déclaration de garantie

Ce produit est couvert par une garantie de deux ans à compter de la date d'achat. Elle ne vaut que pour le premier acheteur et n'est pas transférable. Veuillez conserver le reçu comme preuve de l'achat. La garantie ne couvre que les défauts de matériel ou de fabrication et ne vaut pas pour les pièces d'usure ou pour des dommages dus à un usage inapproprié. En cas de faute de tiers, la garantie est annulée.

Cette garantie ne touche pas vos droits légaux. Veuillez le cas échéant contacter par téléphone le service après-vente. Ce n'est qu'ainsi que le renvoi gratuit de votre produit sera assuré.

○ Fabricant / Service après-vente

Hugo Brennenstuhl GmbH & Co. KG

Seestraße 1-3 · D-72074 Tübingen

H. Brennenstuhl S.A.S.

4 rue de Bruxelles · F-67170 Bernolsheim

lectra-t ag













Blegistrasse 13 · CH-6340 Baar

Pour obtenir de plus amples informations, nous recommandons une visite de notre site à la page Service/FAQ www.brennenstuhl.com



In deze gebruiksaanwijzing/ aan het apparaat wordt gebruik gemaakt van de volgende pictogrammen	Pagina 25
Inleiding	Pagina 24
Doelmatig gebruik	Pagina 24
Verpakkingsinhoud	Pagina 25
Beschrijving van de onderdelen	Pagina 25
Technische informatie	Pagina 25
Veiligheidsinstructies	Pagina 25
Montage	Pagina 26
Gebruik	Pagina 26
Reparaties, onderhoud en opslag	Pagina 26
Afvoer	Pagina 26
Informatie	Pagina 27
Garantieverklaring	Pagina 27
Fabrikant/ Service	Pagina 27

In deze gebruiksaanwijzing / aan het apparaat wordt gebruik gemaakt van de volgende pictogrammen:

	Lees de gebruiksaanwijzing!		Zorg ervoor dat de werkschraag stabiel staat en niet kan omvallen.
	Waarschuwings- en veiligheidsinstructies in acht nemen!		Gebruik het product enkele op vaste, effen oppervlakken.
	Levensgevaar en gevaar voor ongevallen voor kleine kinderen en jongeren!		Gebruik het product in geen geval op een ondergrond met een helling.
	Gebruik de werkschraag nooit als ladder.		Let erop dat de poten compleet zijn uitgeklappt en de spreidbeveiligingen zijn bevestigd, als u de schraag gebruikt.
	Gebruik de schraag niet als stellage of steiger.		Zorg ervoor dat de ondergrond niet vochtig of vet is.
	Zorg ervoor dat de toegelaten draagcapaciteit van 110 kg nooit wordt overschreden.		Borg het werkstuk tegen wegglijden.
	Belast het werkstuk niet aan een zijde.		Controleer de veiligheids- en instelvoorzieningen.
	Gebruik de schraag niet, als deze beschadigd is.		

Stalen schraag MB 110

● Inleiding



Maak u vóór het eerste gebruik vertrouwd met het product. Lees daarvoor de handleiding en de veiligheidsinstructies zorgvuldig door. Bewaar deze gebruiksaanwijzing goed. Overhandig alle documenten bij doorgifte van het product aan derden. Gebruik het product alleen zoals beschreven en voor de aangegeven gebruiksdoelen.

○ Doelmatig gebruik

De werkschraag is bedoeld als behangtafel o.a. voor de thuiswerker of voor hobbygebruik. Op de werkschraag of op de werkplaat staan, is niet toegelaten.

Een ander gebruik als eerder beschreven of een verandering van het product is niet toegestaan en kan tot letsel en/of beschadiging van het product voeren. Voor uit onbedoeld gebruik voortvloeiende schade is de fabrikant niet aansprakelijk. Het product is niet voor zakelijke doeleinden geschikt.

○ Verpakkingsinhoud

- 1 x Stalen schraag
- 1 x Bedieningshandleiding

○ Beschrijving van de onderdelen

Zie daarvoor afbeelding „A“.

- 1 Oplegvlak
- 2 Poten
- 3 Spreidbeveiliging

○ Technische informatie

Type:	MB 110
Afmetingen (uitgeklapt):	63 x 71 cm
Gewicht:	3 kg
Max. draagcapaciteit:	110 kg







Veiligheidsinstructies

BEWAAR ALLE VEILIGHEIDSINSTRUCTIES EN AANWIJZINGEN ZORGVULDIG!

- 
WAARSCHUWING! LEVENSGEVAAR EN GEVAAR VOOR ONGEVALLEN VOOR KLEINE KINDEREN EN JONGEREN! Laat kinderen nooit zonder toezicht hanteren met het verpakkingsmateriaal. Er bestaat gevaar op verstikking door het verpakkingsmateriaal. Kinderen onderschatten vaak het gevaar. Houd het product buiten bereik van kinderen. Deze werkschraag is geen speeltuig.

- 
 Controleer de schraag na de levering en voor iedere ingebruikname om de toestand en de werking van alle onderdelen te beoordelen. Gebruik het product nooit, als het beschadigd is. Anders bestaat er letselgevaar.
- Gebruik geen beschadigde werkschraag.
- 
VOORZICHTIG! Laat kinderen nooit zonder toezicht! Dit product is geen klim- of speeltoestel! Verzeker U ervan dat personen, vooral kinderen, niet op het product klimmen c. q. niet tegen het product aanleunen. Dit product kan uit balans raken en kantelen. Letsel en / beschadigingen kunnen het gevolg zijn.
- 
VOORZICHTIG! VERWONDINGSGEVAAR! Gebruik de werkschraag nooit als ladder.
- 
VOORZICHTIG! VERWONDINGSGEVAAR! Klim nooit op de werkschraag of op het werkoppervlak.
- 
 Zorg ervoor dat de toegelaten draagcapaciteit van 110 kg nooit wordt overschreden.
- 
 Zorg ervoor dat de werkschraag stabiel staat en niet kan omvallen. Dit zou kunnen leiden tot verwondingen of tot schade aan het product.
- 
VOORZICHTIG! GEVAAR OP VERMORZELING! Let bij het openen dichtklappen van de werkschraag op uw vingers.
- 
 Gebruik het product enkele op vaste, effen oppervlakken. Op niet-vaste of oneffen oppervlakken, bv. op kasseien, kan de last verschuiven.
- 
VOORZICHTIG! VERWONDINGSGEVAAR! Gebruik de werkschraag nooit op ondergronden met

een helling. De werkschraag en de werkstukken erop zouden kunnen omkantelen.

-  Let erop dat de poten **2** compleet zijn uitgeklapt en de spreidbeveiligingen **3** zijn bevestigd, als u de schraag gebruikt. Alleen zo kan een veilige stand worden gewaarborgd.
-  Gebruik de schraag niet, als de veiligheidsvoorziening of de lasnaad beschadigd is.
-  **VOORZICHTIG! VERWONDINGSGEVAAR!** Zorg ervoor dat de ondergrond niet vochtig of vet is. Zo niet kan de werkschraag wegschuiven en omvallen.
-  Let erop dat de werkstukken/werkplaat op het oplegvlak **1** niet kunnen/kan wegglijden. Zeker deze indien nodig.
-  Zorg ervoor dat u de werkstukken niet slechts één kant belasten. Zo niet kan het werkstuk uit evenwicht geraken en omvallen.
- Verwijder alle verontreinigingen, bv. natte verf, vuil, olie of sneeuw, van de werkschraag.

● Montage

- Zet de stalen schraag volgens tekening „B” in elkaar.

● Gebruik

De aanwijzingen over hoe de schraag opgesteld dient te worden hebben betrekking op afbeelding „A”.

- Klap de poten **2** compleet uit elkaar.

-  **VOORZICHTIG! KANS OP LETSEL!** Let erop dat de spreidbeveiligingen **3** zijn bevestigd.

Alleen zo kan een veilige stand worden gewaarborgd.

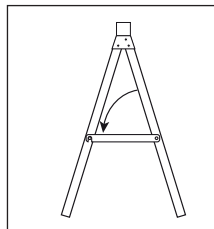

- Controleer of de veiligheidsvoorzieningen op de juiste manier vastzitten.
- Leg het te bewerken werkstuk op het oplegvlak **1**.
- **Opmerking:** gebruik voor lange werkstukken 2 schragen.

- ⚠ **VOORZICHTIG!** Let erop dat de werkstukken op het oplegvlak **1** niet wegglijden.
- Klap de poten **2** weer bij elkaar, als u de schraag niet meer nodig heeft.

● Reparaties, onderhoud en opslag

- Laat reparaties en onderhoudswerkzaamheden door een vakman uitvoeren.
- Bewaar de werkschraag in een droge, gesloten ruimte wanneer u hem langere tijd niet gebruikt.

● Afvoer

De verpakking is uitsluitend vervaardigd van milieuvriendelijk materiaal. Dit kan in de lokale recyclingcontainers worden afgevoerd.

Over actuele afvoermogelijkheden voor uitgediende elektrische apparaten kunt u informeren bij uw gemeente.

● Informatie

○ Garantieverklaring

U hebt op dit product een garantie van 2 jaar vanaf aankoopdatum. Deze garantie geldt enkel voor de eerste koper en is niet overdraagbaar. Bewaar de kassabon als bewijs. De garantie dekt enkel materiaal- of fabricatiefouten, en dekt niet de slijtagedelen of schade als gevolg van ondeskundig gebruik. Bij verantwoordelijkheid tegenover derden vervalt de garantie.

Deze garantie heeft geen invloed op uw wettelijke rechten.

Bij garantiegevallen stelt u zich telefonisch in contact met de onderhoudsdienst. Enkel zo kan een kosteloze inzending van uw apparaat worden gegarandeerd.

○ Fabrikant / Service

Hugo Brennenstuhl GmbH & Co. KG

Seestraße 1-3 · D-72074 Tübingen

H. Brennenstuhl S.A.S.

4 rue de Bruxelles · F-67170 Bernolsheim

lectra-t ag

Blegistrasse 13 · CH-6340 Baar

Meer informatie vindt u onder Service/FAQ's op onze homepage www.brennenstuhl.com





In queste istruzioni d'uso / sull'apparecchio sono riportati i seguenti pittogrammi Pagina 30

Introduzione Pagina 30

 Utilizzo determinato Pagina 30

 Contenuto della confezione Pagina 30

 Descrizione dei pezzi Pagina 31

 Dati tecnici Pagina 31

Avvertenze di sicurezza Pagina 31

Utilizzo Pagina 32

Riparazione, manutenzione e magazzinaggio Pagina 32

Smaltimento Pagina 33

Informazioni Pagina 33

 Dichiarazione di garanzia Pagina 33

 Produttore / Servizio clienti Pagina 33



In queste istruzioni d'uso / sull'apparecchio sono riportati i seguenti pittogrammi:

	Leggere il manuale di istruzioni per l'uso!		Prestate attenzione che il cavalletto sia in posizione stabile e non possa ribaltarsi.
	Rispettare le avvertenze e le indicazioni per la sicurezza!		Utilizzate il prodotto solo su superfici compatte e uniformi.
	Pericolo di morte e di incidenti per bambini e infanti!		Non utilizzare mai il cavalletto su superfici inclinate.
	Non utilizzate mai il cavalletto come scala o simili.		Assicurarsi che le gambe di sostegno siano completamente aperte e che i dispositivi antichiusura siano correttamente installati quando si utilizza il cavalletto.
	Questo cavalletto da lavoro non è un cavalletto per ponteggi o su cui montare.		Prestate attenzione che la superficie sottostante non sia né umida né scivolosa.
	Prestate attenzione a non superare mai la portata massima consentita di 110 kg.		Bloccare il piano di lavoro per evitare scivolamenti.
	Non caricare il pezzo su un solo lato.		Verifica dei dispositivi di sicurezza o di regolazione.
	In caso di danneggiamenti non utilizzare più il cavalletto.		

Cavalletto in acciaio MB 110

● Introduzione



Familiarizzate con il prodotto prima del montaggio. Leggete le seguenti istruzioni di montaggio e le avvertenze di sicurezza.

Conservate bene queste istruzioni. Consegnate altrettanto tutte le documentazioni su questo prodotto quando lo date a terzi. Utilizzate questo prodotto solo come descritto e per gli ambiti d'uso indicati.

○ Utilizzo determinato

Il cavalletto si può utilizzare come tavolo da tappezzeria o simili per il bricolage o per hobby. Non è permesso salire sul cavalletto o sul piano di lavoro. Un altro utilizzo a quello prima descritto o una modifica del prodotto non è lecito e può causare lesioni e/o danni al prodotto stesso. Il produttore non risponde a danni causati da un utilizzo non determinato del prodotto. Il prodotto non è determinato per l'uso professionale.

○ Contenuto della confezione

- 1 x Cavalletto in acciaio
- 1 x Istruzioni per l'uso

○ Descrizione dei pezzi

Su questo, vedere fig. „A“.

- 1 Piano d'appoggio
- 2 Gambe di sostegno
- 3 Dispositivo antichiusura





○ Dati tecnici

Tipo: MB 110
 Misure (aperto): 63 x 71 cm
 Peso: 3 kg
 Capacità di portata massima: 110 kg





Avvertenze di sicurezza

CONSERVARE ACCURATAMENTE TUTTE LE INDICAZIONI E LE AVVERTENZE IN MATERIA DI SICUREZZA!

-  **ATTENZIONE! PERICOLO DI MORTE E DI INCIDENTI PER BAMBINI E INFANTI!** Non lasciare mai i bambini incustoditi con il materiale per imballaggio. Vi è il rischio di soffocamento attraverso il materiale di confezionamento. I bambini tendono spesso a sottovalutare i pericoli. Tenete sempre i bambini lontani dalla portata del prodotto. Il cavalletto non è un giocattolo.
-  Controllare lo stato e il funzionamento di tutti i componenti del cavalletto dopo la consegna e prima di utilizzarlo per la prima volta. Non utilizzare in nessun caso il prodotto se danneggiato. Altrimenti sussiste pericolo di lesioni.
- Non utilizzate il cavalletto se è danneggiato.

-  **ATTENZIONE!** Non lasciate i bambini inosservati! La serra da giardino non è un attrezzo per giocare o arrampicarsi! Assicuratevi che nessuno vi si appoggi, e soprattutto che nessun bambino si arrampichi sulla serra. La serra potrebbe sbilanciarsi e ribaltare. Un'inosservanza può causare pericolo di lesioni e/o danni.
-  **ATTENZIONE! PERICOLO DI INFORTUNIO!** Non utilizzate mai il cavalletto come scala o simili.
-  **ATTENZIONE! PERICOLO DI INFORTUNIO!** Non salite mai sul cavalletto o sul piano di lavoro.
-  Prestate attenzione a non superare mai la portata massima consentita di 110 kg.
-  Prestate attenzione che il cavalletto sia in posizione stabile e non possa ribaltarsi. Eventuali danneggiamenti del prodotto possono esserne infatti le conseguenze.
-  **ATTENZIONE! PERICOLO DI SCHIACCIAMENTO!** State attenti alle Vostre dita nell'aprire e richiudere il cavalletto.
-  Utilizzate il prodotto solo su superfici compatte e uniformi. Su superfici non compatte e non uniformi – come ad esempio superfici in ghiaia – il prodotto potrebbe scivolare.
-  **ATTENZIONE! PERICOLO DI INFORTUNIO!** Non utilizzate in nessun caso il cavalletto su superfici in pendenza. Il cavalletto come eventuali pezzi di lavoro possono ribaltarsi.
-  Assicurarsi che le gambe di sostegno **2** siano completamente aperte e che i dispositivi antichiusura **3** siano

ben installati quando si utilizza il cavalletto. Solo in questo modo è garantito un posizionamento sicuro.

-  Non utilizzare più il cavalletto in caso di dispositivi di sicurezza o di saldature danneggiate.
-  **ATTENZIONE! PERICOLO DI INFORTUNIO!** Prestate attenzione che la superficie sottostante non sia né umida né scivolosa. Il cavalletto può infatti scivolare e ribaltarsi.
-  Assicurarsi che i pezzi da lavorare / il piano di lavoro non possano scivolare dalla superficie di appoggio **1**. Eventualmente fissarli bene.
-  Prestate attenzione che i pezzi di lavoro non facciano pressione da una sola parte. In tal caso infatti il prodotto può essere sbilanciato e ribaltarsi.
- Tenet e ben pulito il prodotto, come ad esempio colore bagnato, sporcizia, olio e neve dal cavalletto.

● Montaggio

- Montare il cavalletto in acciaio in base al disegno „B“.

● Utilizzo

Le avvertenze di installazione si riferiscono alla figura „A“.

- Aprire completamente le gambe di sostegno **2**.



ATTENZIONE! PERICOLO DI LESIONI!

Assicurarsi che i dispositivi antiscivolo **3** siano ben installati.

Solo in questo modo è garantito un posizionamento sicuro.

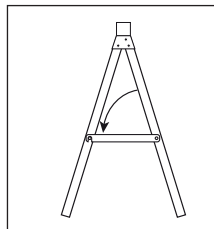

- Verificare la corretta installazione dei dispositivi di sicurezza.
 - Collocare il pezzo da lavorare sulla superficie di appoggio **1**.
- Avvertenza:** in caso di lavori con pezzi lunghi utilizzare 2 cavalletti.
- ⚠ **ATTENZIONE!** Assicurarsi che i pezzi da lavorare non scivolino dalla superficie di appoggio **1**.
 - Chiudere nuovamente le gambe di sostegno **2** quando il cavalletto non viene utilizzato.

● Riparazione, manutenzione e magazzinaggio

- Lasciare eseguire riparazioni e lavori di manutenzione al cavalletto da una persona qualificata.
- Immagazzinate il cavalletto in un luogo asciutto e al chiuso, se non doveste farne utilizzo per una durata di tempo più lunga.

● Smaltimento

L'imballaggio e il materiale di imballaggio sono realizzati esclusivamente con materiali ecologici, che possono essere smaltiti nei contenitori di riciclaggio locali.

Per le norme di smaltimento attualmente in vigore per gli apparecchi elettronici, rivolgersi all'amministrazione comunale o cittadina.

● Informazioni

○ Dichiarazione di garanzia

Per questo prodotto otterrete 2 anni di garanzia a partire dalla data di acquisto. Questa garanzia vale solo per il primo acquirente e non é trasmissibile. Vi preghiamo di custodire la ricevuta come prova. La garanzia vale solo per difetti di materiale o di fabbricazione e non vale per parti di macchine o per danneggiamenti dovuti ad un utilizzo non corretto del prodotto. In caso di danneggiamenti da parte di una terza persona la garanzia non gode di alcuna validità.

I Vostri diritti secondo la legge non verranno limitati attraverso questa garanzia.

In caso di garanzia Vi preghiamo di contattare telefonicamente il nostro Servizio Clienti. Solo in questo modo potremo garantirVi la spedizione gratis del Vostro prodotto.

○ Produttore / Servizio clienti

Hugo Brennenstuhl GmbH & Co. KG

Seestraße 1-3 · D-72074 Tübingen

H. Brennenstuhl S.A.S.

4 rue de Bruxelles · F-67170 Bernolsheim

lectra-t ag

Blegistrasse 13 · CH-6340 Baar















Per ulteriori informazioni consigliamo di consultare l'area Service/FAQ sul nostro sito www.brennenstuhl.com





W niniejszej instrukcji obsługi urządzenia zastosowano następujące piktogramy	Strona 36
Wstęp	Strona 36
Zastosowanie zgodne z przeznaczeniem	Strona 36
Zakres dostawy	Strona 37
Opis części	Strona 37
Dane techniczne	Strona 37
Wskazówki dotyczące bezpieczeństwa	Strona 37
Montaż	Strona 38
Zastosowanie	Strona 38
Naprawa, konserwacja i przechowywanie	Strona 38
Utylizacja	Strona 39
Informacje	Strona 39
Oświadczenie gwarancyjne	Strona 39
Producent/ Serwis	Strona 39

W niniejszej instrukcji obsługi urządzenia zastosowano następujące piktogramy:

	Przeczytać instrukcję obsługi!		Uważać na to, aby koźlak roboczy stał bezpiecznie i nie mógł się przewrócić.
	Przestrzegać wskazówek ostrzegawczych i bezpieczeństwa!		Używać produktu wyłącznie na stałych, równych powierzchniach.
	Zagrożenie życia i niebezpieczeństwo wypadku dla dzieci!		W żadnym wypadku nie używać koźlaka roboczego na podłożach nachylonych.
	Nigdy nie używać koźlaka roboczego jako drabiny itp.		Należy uważać na to, aby nóżki były kompletnie rozłożone, a zabezpieczenia przed rozwarciem założone podczas używania koźlaka roboczego.
	Tego koźlaka roboczego nie należy używać jako koźlaka rusztowania murarskiego.		Zwrócić uwagę na to, aby podłoże nie było wilgotne ani oleiste.
	Zwracać uwagę na to, aby nigdy nie przekraczać dopuszczalnego obciążenia znamionowego 110 kg.		Zabezpieczyć płytę roboczą przed ześlizgnięciem.
	Nie obciążać obrabianego przedmiotu z jednej strony.		Kontrola zabezpieczenia lub regulacji.
	W razie uszkodzenia nie używać więcej koźlaka roboczego.		

Stalowy koźlak roboczy MB 110**● Wstęp**

Przed pierwszym zastosowaniem należy najpierw zapoznać się z niniejszym produktem. Proszę uważnie przeczytać instrukcję obsługi oraz wskazówki dotyczące bezpieczeństwa. Instrukcję obsługi należy starannie przechowywać. W przypadku przekazania produktu innej osobie należy dołączyć do niego całą jego dokumentację. Produkt należy stosować wyłącznie zgodnie z jego poniżej opisanym przeznaczeniem.

○ Zastosowanie zgodne z przeznaczeniem

Koźlak roboczy przeznaczony jest do zastosowania domowego i hobbystycznego jako stół do tapetowania itp. Niedopuszczalne jest wchodzenie na koźlak roboczy lub płytę roboczą. Inne zastosowanie lub zmiany produktu są niezgodne z jego przeznaczeniem i kryją w sobie znaczne ryzyko wypadków. Za szkody, które powstały w wyniku użycia niezgodnego z przeznaczeniem, producent nie ponosi odpowiedzialności. Produkt nie jest przeznaczony do użytku komercyjnego.

○ Zakres dostawy

- 1 x Stalowy koziół roboczy
- 1 x Instrukcja obsługi

○ Opis części

W tym celu patrz rysunek „A”.

- 1 Powierzchnia robocza
- 2 Nóżki
- 3 Zabezpieczenie przed rozwarciem

○ Dane techniczne









Typ:	MB 110
Wymiary (po rozłożeniu):	63 x 71 cm
Ciężar:	3 kg
Maks. nośność:	110 kg

Wskazówki dotyczące bezpieczeństwa







PROSZĘ STARANNIE ZACHOWAĆ WSZYSTKIE WSKAZÓWKI DOTYCZĄCE BEZPIECZEŃSTWA I INSTRUKCJE NA PRZYSZŁOŚĆ!

-  **OSTRZEŻENIE! ZAGROŻENIE ŻYCIA I NIEBEZPIECZEŃSTWO WYPADKU DLA DZIECI!**
Ze względu na ryzyko uduszenia się nigdy nie pozostawiać dzieci bez nadzoru z materiałem opakowaniowym. Istnieje zagrożenie uduszeniem wywołane przez materiał opakowaniowy. Dzieci często nie dostrzegają niebezpieczeństwa. Dzieci nie powinny mieć

dostępu do produktu. Koziół roboczy nie jest zabawką.

-  Po dostawie i przed każdym użyciem sprawdzić koźła roboczego, aby stwierdzić, jaki jest stan i działanie wszystkich części. Nie używać produktu, jeżeli jest uszkodzony. W innym razie grozi to niebezpieczeństwem odniesienia obrażeń.
- Nie używać uszkodzonego koźła roboczego.
-  **OSTROŻNIE!** Nie pozostawiać dzieci bez nadzoru! Produkt nie jest zabawką ani drabinką do wspinaczek! Należy upewnić się, czy nikt, a szczególnie dzieci, nie wspinają się na produkt, bądź się na nim zawieszają. Produkt może się przechylić i przewrócić. Następstwem czego mogą być urazy i/lub szkody materialne.
-  **OSTROŻNIE! NIEBEZPIECZEŃSTWO OBRAŻEN CIAŁA!** Nigdy nie używać koźła roboczego jako drabiny itp.
-  **OSTROŻNIE! NIEBEZPIECZEŃSTWO OBRAŻEN CIAŁA!** Nigdy nie wchodzić na koźła roboczego ani na płytę roboczą.
-  Zwracać uwagę na to, aby nigdy nie przekraczać dopuszczalnego obciążenia znamionowego 110 kg.
-  Uważać na to, aby koziół roboczy stał bezpiecznie i nie mógł się przewrócić. Następstwem tego mogą być urazy i/lub uszkodzenie produktu.
-  **OSTROŻNIE! NIEBEZPIECZEŃSTWO ZMIAŹDZENIA!** Przy rozkładaniu i składaniu koźła roboczego uważać na palce.
-  Używać produktu wyłącznie na stałych, równych powierzchniach. Na powierzchniach nieumocnionych

i nierównych – takich jak na przykład nawierzchnie tłuczniowe – może dojść do zsunienia się obciążenia.

-  **OSTROŻNIE! NIEBEZPIECZEŃSTWO OBRAŻEŃ CIAŁA!** W żadnym wypadku nie używać koźła roboczego na podłożach nachylonych. Koziół roboczy lub ewentualne leżące na nim obrabiane przedmioty mogą się przewrócić.
-  Należy uważać na to, aby nóżki były **2** kompletnie rozłożone, a zabezpieczenia przed rozwarciem **3** założone podczas używania koźła roboczego. Tylko w ten sposób zapewnia się bezpieczną stabilność.
-  W przypadku uszkodzonego zabezpieczenia lub spawu nie używać już koźła roboczego.
-  **OSTROŻNIE! NIEBEZPIECZEŃSTWO OBRAŻEŃ CIAŁA!** Zwrócić uwagę na to, aby podłoże nie było wilgotne ani oleiste. Koziół roboczy może się poślizgnąć i przewrócić.
-  Zwrócić uwagę na to, aby obrabiane przedmioty / płyta robocza nie mogły / mogła ślizgać się po powierzchni roboczej **1**. Ewentualnie zabezpieczyć je.
-  Należy zwrócić na to uwagę, aby obrabiane przedmioty nie obciążały jednej strony. W innym razie obrabiany przedmiot może utracić równowagę i spaść.
- Usunąć wszystkie zanieczyszczenia z koźła roboczego, takie jak np. mokra farba, brud, olej lub śnieg.

● Montaż

- Złożyć stalowego koźła roboczego zgodnie z rysunkiem „B”.

● Zastosowanie

Wskazówki dotyczące ustawiania odnoszą się do rysunku „A”.

- Całkowicie rozłożyć nóżki **2**.
-  **OSTROŻNIE! NIEBEZPIECZEŃSTWO OBRAŻEŃ CIAŁA!** Zwrócić uwagę na to, aby założone były zabezpieczenia przed rozwarciem **3**. Tylko w ten sposób zapewnia się bezpieczną stabilność.

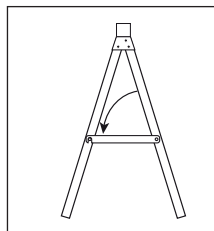

- Sprawdzić zabezpieczenia pod kątem prawidłowego osadzenia.
 - Położyć przedmiot do obróbki na powierzchni roboczej **1**.
- Wskazówka:** Do długich obrabianych przedmiotów użyć 2 koźłó roboczych.
- ⚠ **OSTROŻNIE!** Zwrócić uwagę na to, aby obrabiane przedmioty nie ślizgały się po powierzchni roboczej **1**.
 - Ponownie złożyć nóżki **2** razem, jeśli koziół roboczy nie jest już używany.

● Naprawa, konserwacja i przechowywanie

- Naprawy i prace konserwacyjne koźła roboczego należy zlecać wykwalifikowanemu w tym zakresie specjalście.

- Kozła roboczego należy przechowywać w suchym, zamkniętym pomieszczeniu, jeśli nie jest używany przez dłuższy czas.

● Utylizacja

Opakowania i materiał pakunkowy składają się wyłącznie z materiału przyjaznego dla środowiska. Można je usunąć do miejscowych kontenerów na recykling.

Aktualnie obowiązujące przepisy w zakresie usuwania wysłużonych produktów można uzyskać w urzędach gminnych lub miejskich.

● Informacje

○ Oświadczenie gwarancyjne

Urządzenie objęte jest 2-letnią gwarancją, licząc od daty zakupu. Obowiązuje to tylko dla pierwszego kupującego i nie podlega przeniesieniu. Paragon należy zachować jako dowód dokonania zakupu. Gwarancja odnosi się tylko do wad materiałowych lub fabrycznych i nie dotyczy części zużywających się lub uszkodzeń wynikłych z niewłaściwego użycia. Gwarancja wygasa przez winę osób trzecich.

Niniejsza gwarancja nie ogranicza ustawowych praw nabywcy.

W przypadku roszczeń gwarancyjnych należy skontaktować się telefonicznie z serwisem. Tylko w ten sposób można zagwarantować bezpłatne odesłanie zakupionego produktu.

○ Producent / Serwis

Hugo Brennenstuhl GmbH & Co. KG

Seestraße 1-3 · D-72074 Tübingen

H. Brennenstuhl S.A.S.

4 rue de Bruxelles · F-67170 Bernolsheim

lectra-t ag















Blegistrasse 13 · CH-6340 Baar

Więcej informacji można znaleźć w dziale Service/FAQ's na naszej stronie internetowej www.brennenstuhl.com



Følgende piktogrammer anvendes i denne brugsanvisning/på produktet	Side 42
Indledning	Side 42
Formålsbestemt anvendelse	Side 42
Leveringsomfang	Side 42
Beskrivelse af dele	Side 43
Tekniske data.....	Side 43
Sikkerhedshenvisninger	Side 43
Montage	Side 44
Anvendelse	Side 44
Reparation, vedligeholdelse og opbevaring	Side 44
Bortskaffelse	Side 44
Informationer	Side 44
Garantierklæring.....	Side 44
Producent / Service	Side 45

Følgende piktogrammer anvendes i denne brugsanvisning/på produktet:

	Læs betjeningsvejledningen!		Sørg for at arbejdsbukken står sikkert og ikke kan vælte omkuld.
	Overhold advarsels- og sikkerhedshenvisninger!		Produktet må kun benyttes på faste og jævne flader.
	Livs- og ulykkesfare for småbørn og børn!		Anvend under ingen omstændigheder arbejdsbukken på underlag med fald.
	Anvend aldrig arbejdsbukken som stige e.l.		Sørg for at benene er klappet helt ud og sikringsstiverne er foldet ud under anvendelse af arbejdsbukken.
	Denne arbejdsbuk må ikke anvendes som stilladsbuk.		Sørg for at underlaget hverken er fugtigt eller fyldt med olie.
	Sørg for at den tilladte bæreevne på 110 kg ikke overskrides.		Arbejdspladen skal sikres mod glidning.
	Undgå at belaste arbejdsstykke ensidigt.		Kontrollér alle sikkerheds- og indstillingsdele.
	Undgå at bruge arbejdsbukken efter konstatering af evt. beskadigelse.		

Stål-arbejdsbuk MB 110

● Indledning



Gør dig fortrolig med produktet inden første ibrugtagning. Læs betjeningsvejledningen og sikkerhedsvejledningen inden ibrugtagning.

Opbevar betjeningsvejledningen sikkert til senere brug. Udlever alle bilag ved videregivelse af produktet til tredjemand. Brug kun produktet som beskrevet og kun til de angivne anvendelsesområder.

○ Formålsbestemt anvendelse

Arbejdsbukken er fremstillet til brug som tapetseringsbord eller lign. til privat og hobbymæssig brug. Det er ikke tilladt at stå på arbejdsbukken eller arbejdspladen. Andre anvendelser eller forandringer af produktet er ikke bestemmelsesmæssige og skjuler betydelige ulykkesfarer. For skader, som er opstået på grund af uhensigtsmæssig håndtering, hæfter producenten ikke. Produktet er ikke beregnet til den erhvervmæssige anvendelse.

○ Leveringsomfang

- 1 x Stål arbejdsbuk
- 1 x Brugervejledning

● Beskrivelse af dele

Se hertil figur „A“.

- 1 Platform
- 2 Ben
- 3 Sikringsstivere

○ Tekniske data

Type:	MB 110
Mål (udklappet):	63 x 71 cm
Vægt:	3 kg
Maks. bæreevne:	110 kg













Sikkerhedshenvisninger

OPBEVAR ALLE SIKKERHEDSHENVISNINGER OG ANVISNINGER OMHYGGELIGT!

- 
ADVARSEL! LIVS- OG ULYKKEFARE FOR SMÅBØRN OG BØRN! Lad aldrig børn være alene og uden opsyn i nærheden af emballagemateriale. Børn undervurderer ofte farerne. Hold altid børn på afstand af produktet. Arbejdsbukken er ikke et legetøj.
- 
 Kontrollér arbejdsbukken efter levering og inden den første brug, for at konstatere alle deles tilstand og funktion. Anvend under ingen omstændigheder produktet, når det er beskadiget. Ellers består der risiko for tilskadekomst.
- Undgå at bruge en beskadiget arbejdsbuk.
- 
ADVARSEL! Lad ikke børn være uden opsyn! Produktet er ikke noget klatre- eller legeapparat! Sørg for at

ingen personer og især ikke børn klatrer op på produktet eller læner sig op ad det. Produktet kan miste balancen og vælte. Personskader og/eller beskadigelser kan være følgen.

- 
ADVARSEL! FARE FOR TILSKADEKOMST! Anvend aldrig arbejdsbukken som stige e.l.
- 
ADVARSEL! FARE FOR TILSKADEKOMST! Undgå at bestige arbejdsbukken eller arbejdspladen.
- 
 Sørg for at den tilladte nominelle last på 110 kg aldrig bliver overskredet.
- 
 Sørg for at arbejdsbukken står sikkert og ikke kan vælte omkuld. Personskader og/eller materielle skader på produktet kunne blive følgen.
- 
ADVARSEL! FARE FOR KVÆSTELSE! Vær opmærksom på fingrene, når arbejdsbukken klappes op og sammen.
- 
 Produktet må kun benyttes på faste og jævne flader. På ubefæstede og ujævne flader – f.eks. på skærvælager – kan man risikere at lasten skrider.
- 
ADVARSEL! FARE FOR TILSKADEKOMST! Anvend under ingen omstændighed arbejdsbukken på underlag med fald. Arbejdsbukken samt eventuelle påliggende arbejdsstykker kan vælte.
- 
 Sørg for at benene 2 er klappet helt ud og sikringsstiverne 3 anvendes under brugen af arbejdsbukken. Kun sådan er en sikker stand garanteret.
- 
 Ved beskadiget sikrings- og indstillingsanordning eller svejsesøm, må produktet ikke anvendes.
- 
ADVARSEL! FARE FOR TILSKADEKOMST! Sørg for at underlaget

- 

hverken er fugtigt eller fyldt med olie. Arbejdsbukken kan glide væk og vælte.
- 

Sørg for at arbejdsstykkerne/arbejdspladen på platformen **1** ikke kan glide væk. Disse bør i givet fald sikres.
- 

Sørg for at arbejdsstykkerne ikke bliver belastet ensidigt. I modsat fald kan arbejdsstykket miste balancen og falde ned.
- Fjern al snavs, f.eks. våd farve, smuds, olie eller sne fra arbejdsbukken.

● Montage

- Saml stå arbejdsbukken iht. figur „B“.

● Anvendelse

Se figur „A“ for opstillingsvejledning.

- Klap benene **2** helt ud.
-  **ADVARSEL! FARE FOR TILSKADEKOMST!** Sørg for at sikringsstiverne **3** er foldet helt ud.

Kun sådan er en sikker stand garanteret.

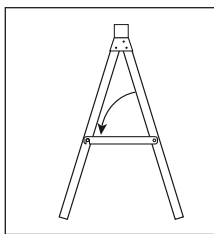

- Kontrollér at sikringsanordningerne sidder korrekt.
- Læg arbejdsstykket, som skal bearbejdes på platformen **1**.

Bemærk: Til lange arbejdsstykker skal der bruges 2 arbejdsbukke.

- ▲ **ADVARSEL!** Sørg for at arbejdsstykkerne på platformen **1** ikke kan glide væk.
 - Klap benene **2** sammen, når arbejdsbukken ikke længere skal bruges.

● Reparation, vedligeholdelse og opbevaring

- Reparationer og vedligeholdelsesarbejder på arbejdsbukken skal gennemføres af en fagkyndig person.
- Opbevar arbejdsbukken i et tørt, lukket rum, hvis den ikke skal anvendes i længere tid.

● Bortskaffelse

Emballagen og emballagematerialet består udelukkende af miljøvenlige materialer. De kan bortskaffes i de kommunale genbrugsbeholdere. De aktuelt gældende bortskaffelsesregler for udtjente produkter fås hos de lokale myndigheder.

● Informationer

○ Garantierklæring

Der er 2 års garanti fra købsdato på dette produkt. Garantien gælder kun for første køber af produktet og kan ikke overdrages. Opbevar kassebonen som dokumentation for købet. Garantien gælder kun for materiale- eller fabriktionsfejl, men ikke for sliddele eller beskadigelser gennem uhensigtsmæssig håndtering. Garantien ophører ved fremmed indgreb.

Deres lovmæssige rettigheder indskrænkes ikke af denne garanti.

I garantitilfælde bedes du kontakte service-afdelingen telefonisk. Kun på denne måde kan en gratis indsendelse af deres apparat garanteres.

● Producent/Service

Hugo Brennenstuhl GmbH & Co. KG

Seestrasse 1-3 D-72074 Tübingen

H. Brennenstuhl S.A.S.

4 rue de Bruxelles F-67170 Bernolsherim

lectra-t ag

Blegisstrasse 13 CH-6340 Baar

For yderligere informationer anbefaler vi service-området/FAQ på vores hjemmeside www.brennenstuhl.com

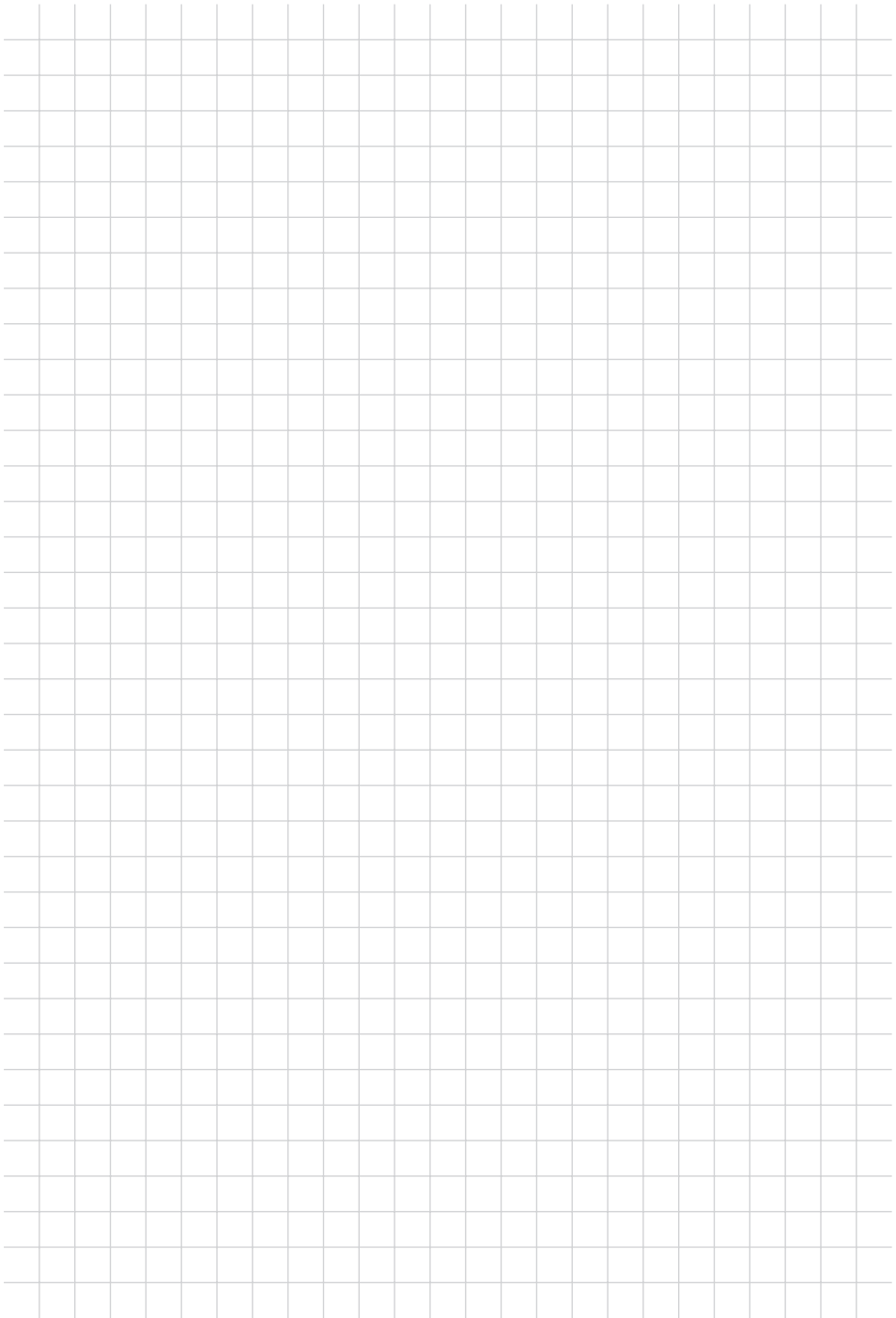



Hugo Brennenstuhl GmbH & Co. KG

Seestraße 1-3 · D-72074 Tübingen

H. Brennenstuhl S.A.S.

4 rue de Bruxelles · F-67170 Bernolsheim

lectra-t ag

Blegistrasse 13 · CH-6340 Baar

www.brennenstuhl.com

Stand der Informationen · Last Information

Update · Version des informations · Stand van

de informatie · Versione delle informazioni

Stan informacj · Stav informácií: 08 / 2017

Ident.-No.: 0489412/0817-DE/GB/FR/NL/IT/PL/DK

