



# KGT

KREATIVE GARTENTECHNIK

## MODUL: TÜRGIEBEL









## MONTAGEANLEITUNG



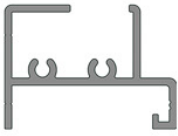

# STÜCKLISTE TÜRGIEBEL

Pos.		Bezeichnung	Art.-Nr.	Anzahl	Abmessung in mm
S12 S1		Sechskantschraube M6 x 12 Mutter M6	9999 0124 9999 0128	6 8	- Standard - mit Fundamentrahmen
S9		Linsenkopfschraube 4,2 x 13	9999 0144	6	
S13		Linsenkopfschraube 4,8 x 45	9999 0150	4	
S19		Senkkopfschraube 4,8 x 25 (Scharniere)	9999 0163	8	
S21		Blindstopfen	9999 0097	2	
S24		Senkkopfschraube 4,8 x 38 (Kunststoffgleiter V16)	9999 0165	2	evtl. bereits vormontiert
V5		Verbindungsplatte	9999 0028	2	
V9		Eckverbinder, Bodenprofil	9999 0003	2	
V15		Befestigungswinkel gekröpft (Standardbefestigung, ohne Fundamentrahmen) Siehe hierzu auch Seite 09	9999 0207	2	
V16		Kunststoffgleiter	9999 0019	2	evtl. bereits vormontiert
V51		Metallscharnier, schwarz	9999 0358	4	

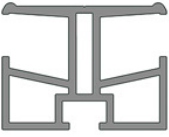
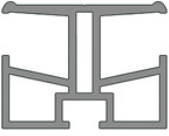
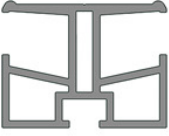

# STÜCKLISTE TÜRGIEBEL

Pos.		Bezeichnung	Art.-Nr.	Anzahl	Abmessung in mm
1.1		Bodenprofil, Giebel		1	Rose II 2238 Rose III 2238 Rose IV 2238 Orchidee III 2874 Orchidee IV 2874
1.2.1		Randsprosse, links (v. Außen)		1	Rose II 1453 Rose III 1453 Rose IV 1453 Orchidee III 1453 Orchidee IV 1453
1.3.1		Randsprosse, rechts (v. Außen)		1	Rose II 1453 Rose III 1453 Rose IV 1453 Orchidee III 1453 Orchidee IV 1453
1.4		Ortgangprofil, links (v. Außen)		1	Rose II 1283 Rose III 1283 Rose IV 1283 Orchidee III 1650 Orchidee IV 1650
1.5		Ortgangprofil, rechts (v. Außen)		1	Rose II 1283 Rose III 1283 Rose IV 1283 Orchidee III 1650 Orchidee IV 1650
1.6		Türzarge, links (v. Außen) (mit Schräge)		1	Rose II 1876 Rose III 1876 Rose IV 1876 Orchidee III 2059 Orchidee IV 2059

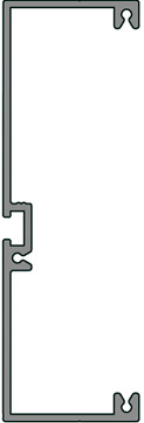
# STÜCKLISTE TÜRGIEBEL

Pos.		Bezeichnung	Art.-Nr.	Anzahl	Abmessung in mm
1.7		Türzarge, rechts (v. Außen) (mit Schräge & Bohrungen)		1	Rose II 1876 Rose III 1876 Rose IV 1876 Orchidee III 2059 Orchidee IV 2059
1.8		Türzarge, oben		1	Rose II 758 Rose III 758 Rose IV 758 Orchidee III 758 Orchidee IV 758
1.9		Querriegel, links & rechts		2	Rose II 702 Rose III 702 Rose IV 702 Orchidee III 1020 Orchidee IV 1020
V27		Befestigungslasche (Sprosse/Fundamentrahmen)  Zubehörartikel, Bauteil ist nur in Verbindung mit dem Modul <u>Fundamentrahmen</u> erhältlich und gehört nicht zum Liefer- umfang.	9999 0267	2	
6.1		Fundamentrahmenprofil, Giebel  Zubehörartikel, Bauteil ist nur in Verbindung mit dem Modul <u>Fundamentrahmen</u> erhältlich und gehört nicht zum Liefer- umfang.		1	Rose II 2188 Rose III 2188 Rose IV 2188 Orchidee III 2824 Orchidee IV 2824

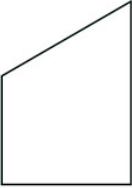
# STÜCKLISTE TÜRGIEBEL

Pos.		Bezeichnung	Art.-Nr.	Anzahl	Abmessung in mm
		ISO Hohlkammerplatte (jeweils 1x links / 1x rechts)		2 2 2 2 2	Rose II 730x1135 Rose III 730x1135 Rose IV 730x1135 Orchidee III 1048x1319 Orchidee IV 1048x1319  je nach Hersteller 2x identisch. Bitte Plattenfolie beachten!
		ISO Hohlkammerplatte		2 2 2 2 2	Rose II 730x728 Rose III 730x728 Rose IV 730x728 Orchidee III 1048x728 Orchidee IV 1048x728
		ISO Hohlkammerplatte		1 1 1 1 1	Rose II 779x239 Rose III 779x239 Rose IV 779x239 Orchidee III 779x239 Orchidee IV 779x239
		Ende der Stückliste			

Anischt von Innen

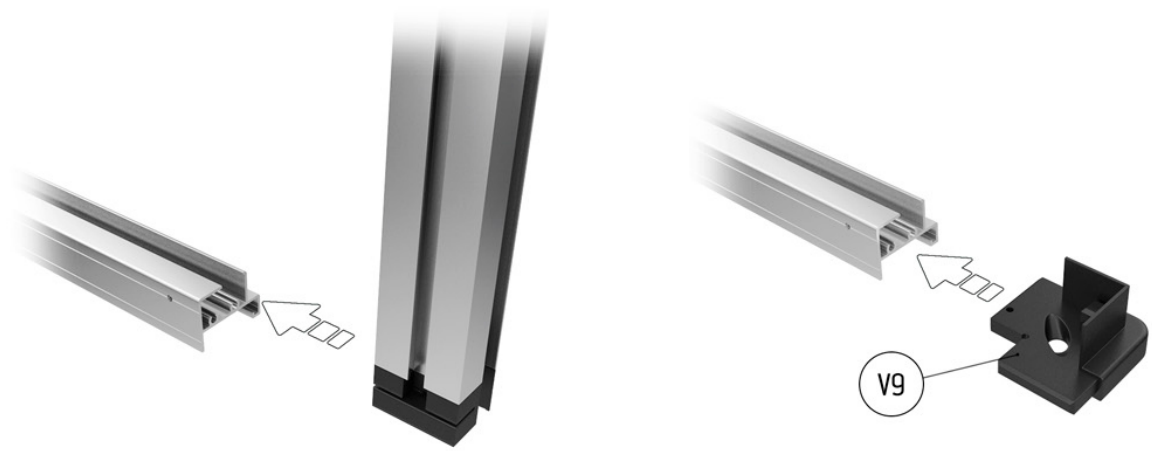
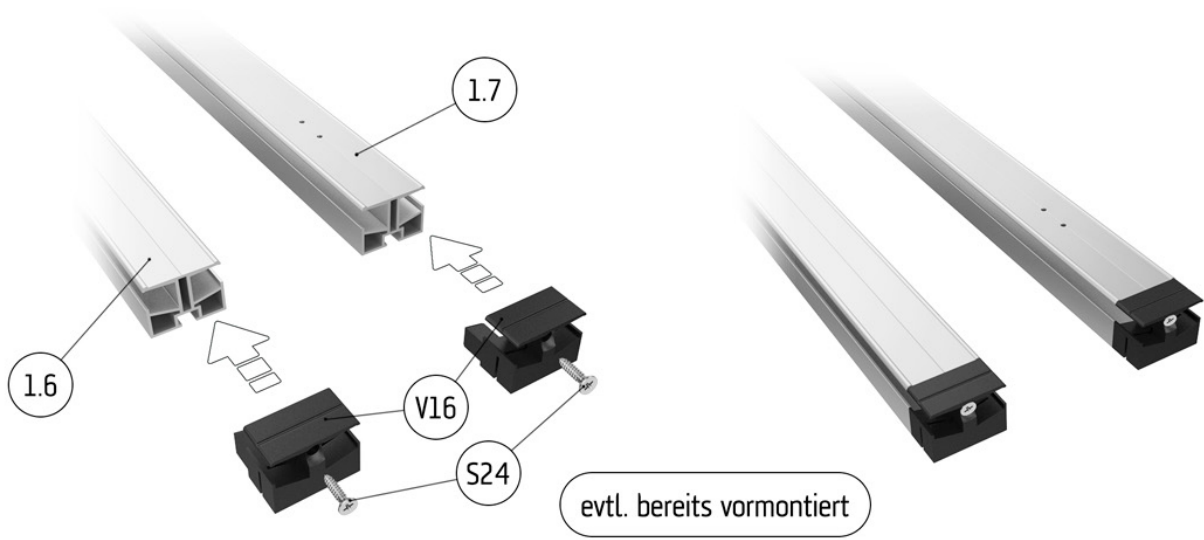
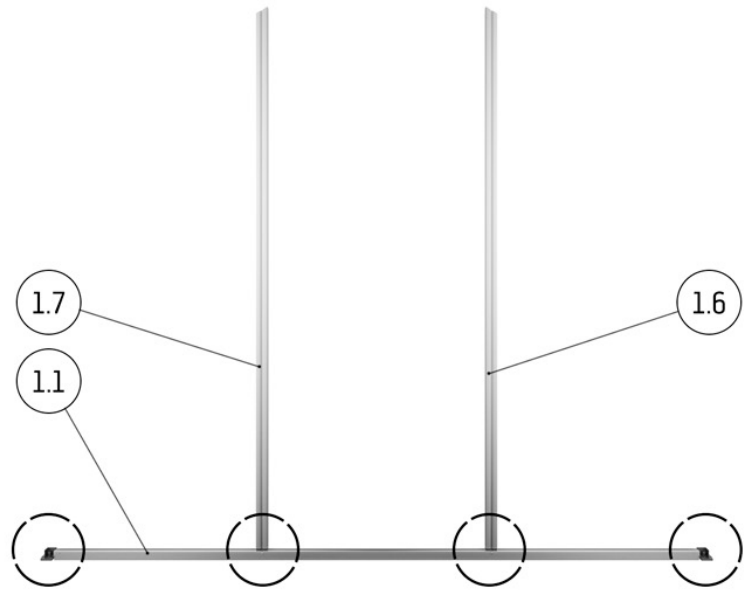

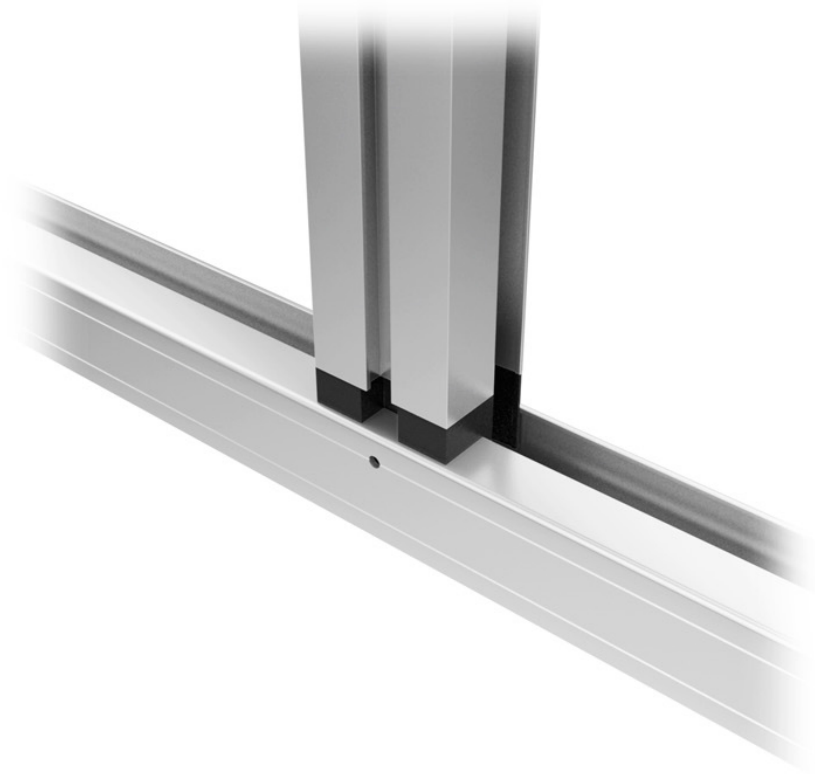
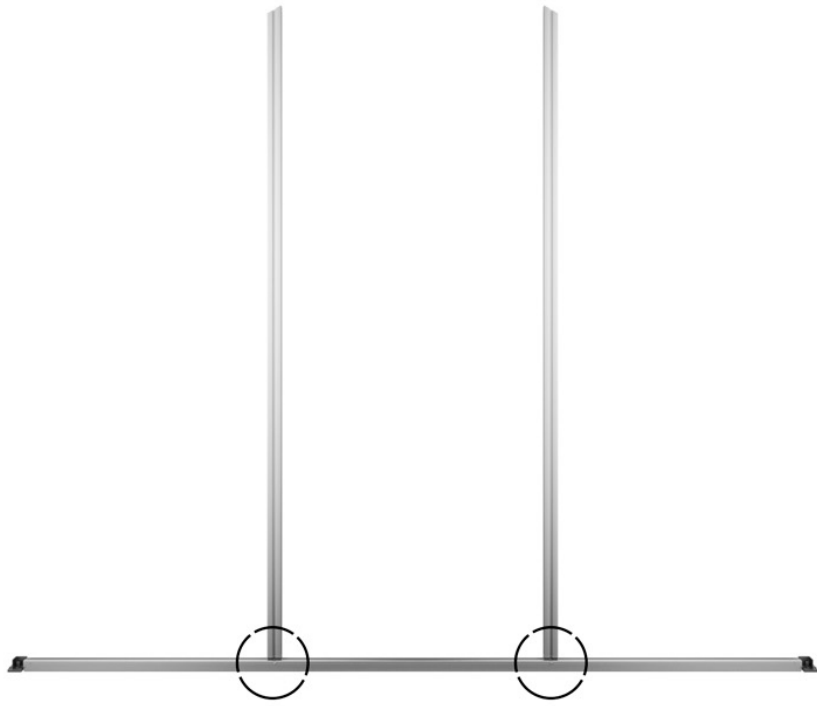

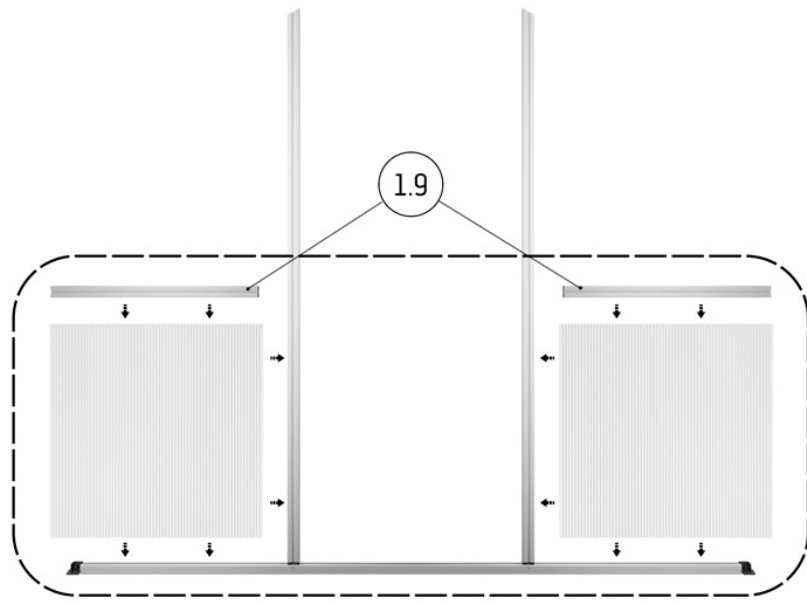

Bei der Montage der Verglasung  
auf den korrekten Einbau der  
Innen- und Aussenseite achten!  
[Beschriftung auf den  
ISO-Hohlkammerplatten]

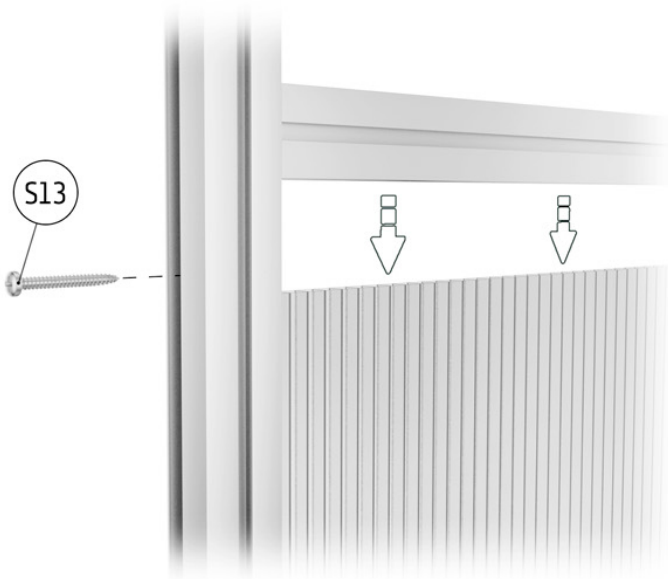
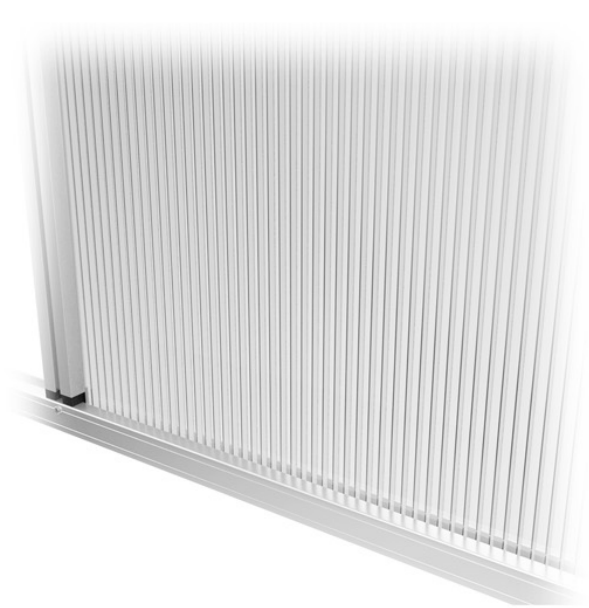
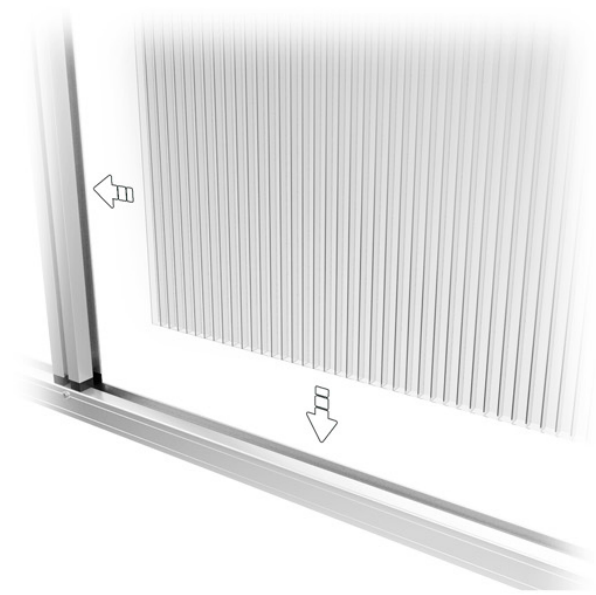
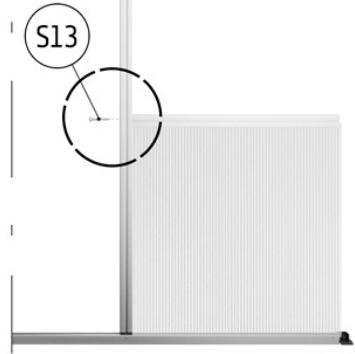



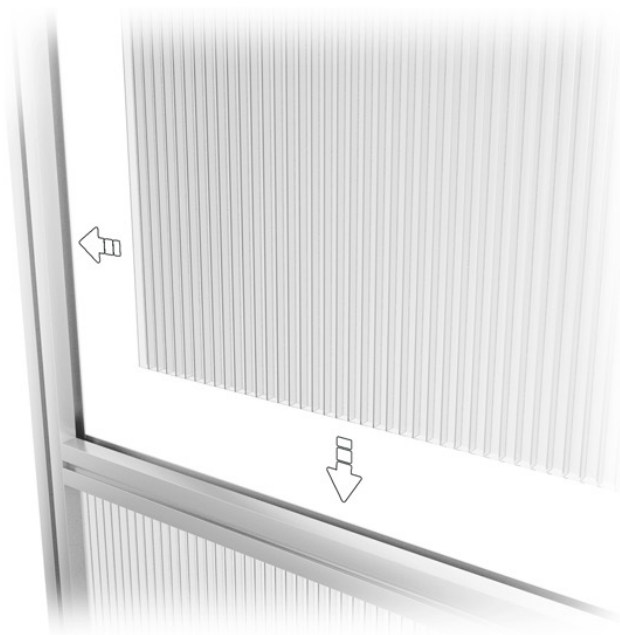
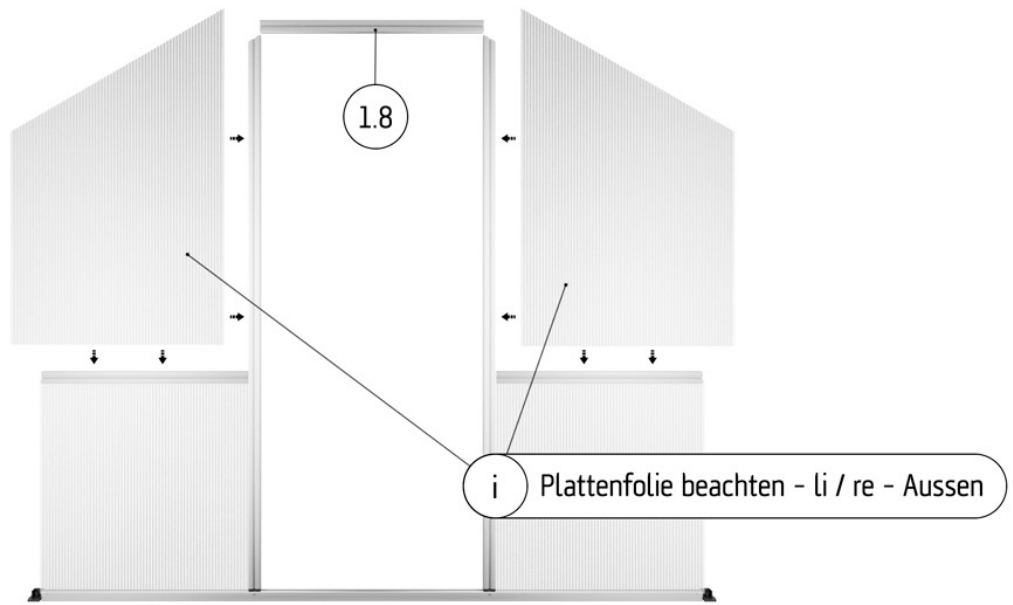

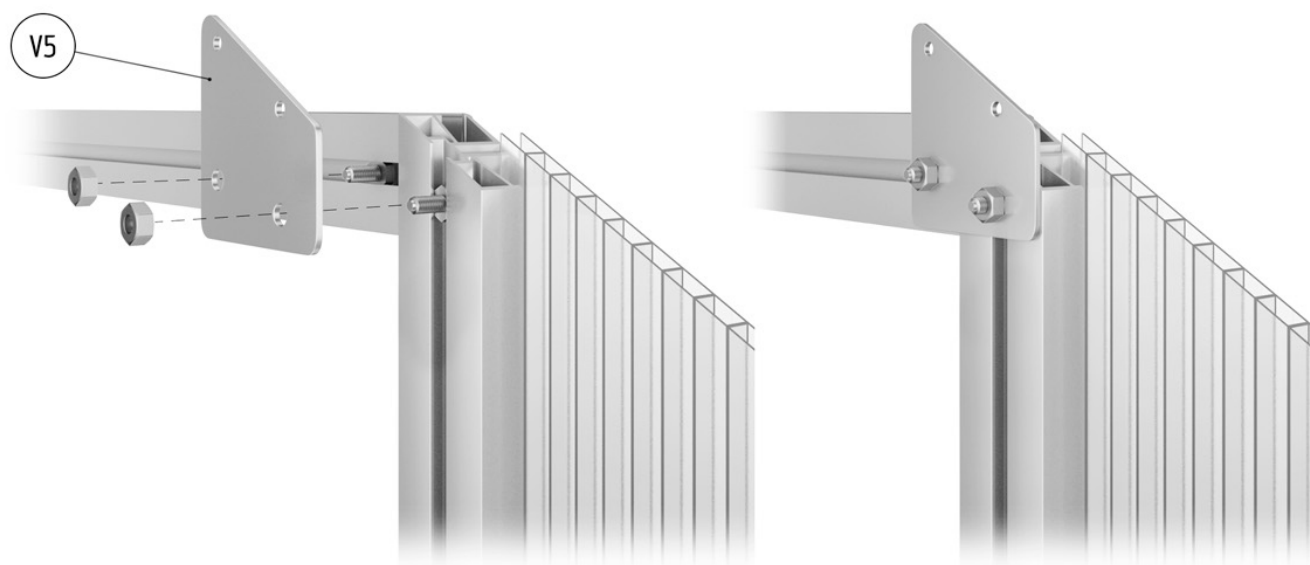
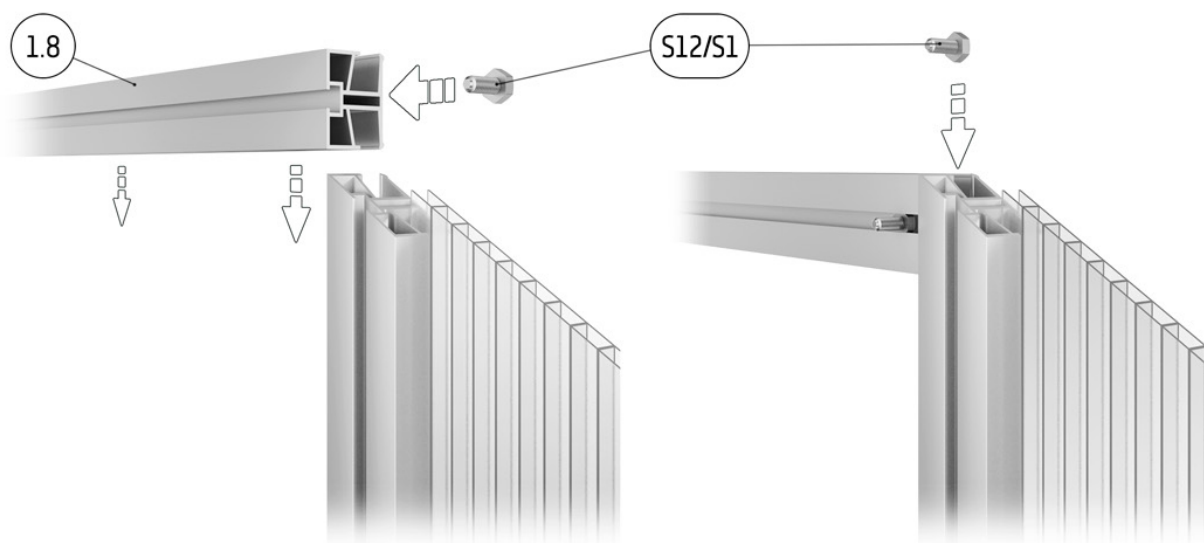
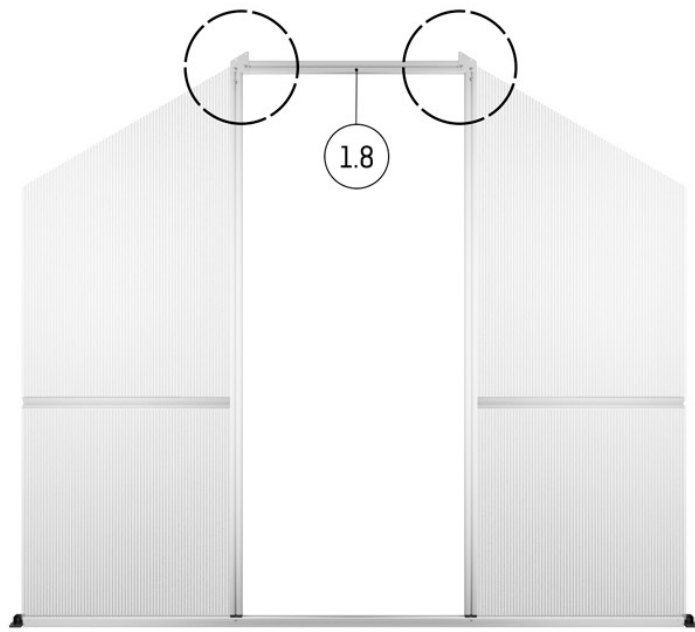

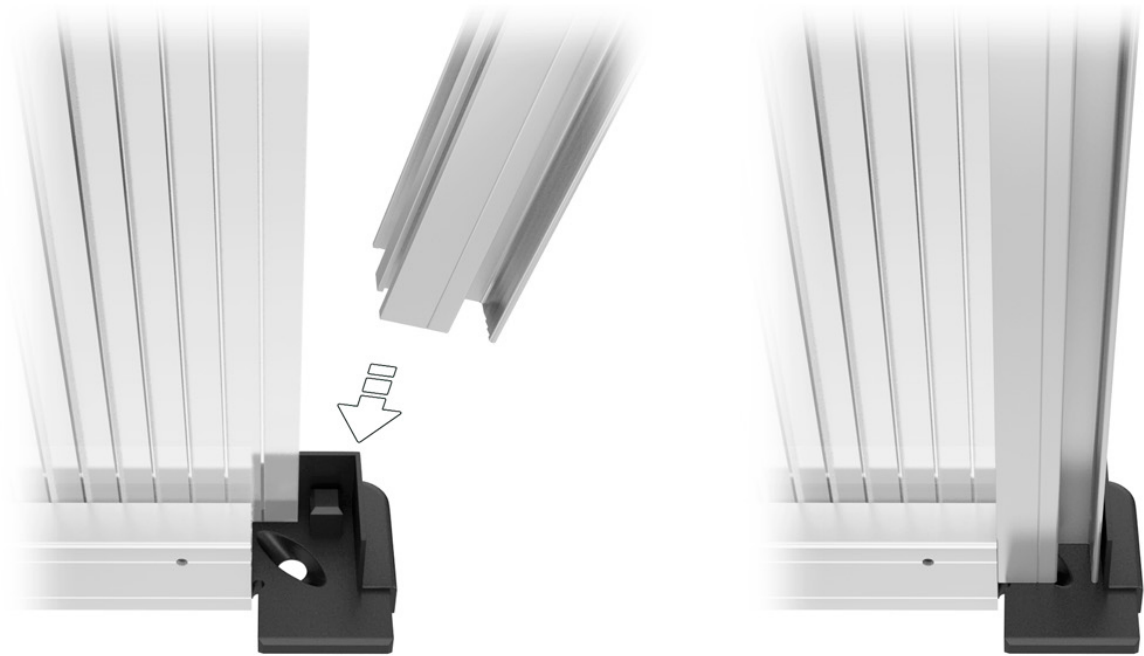
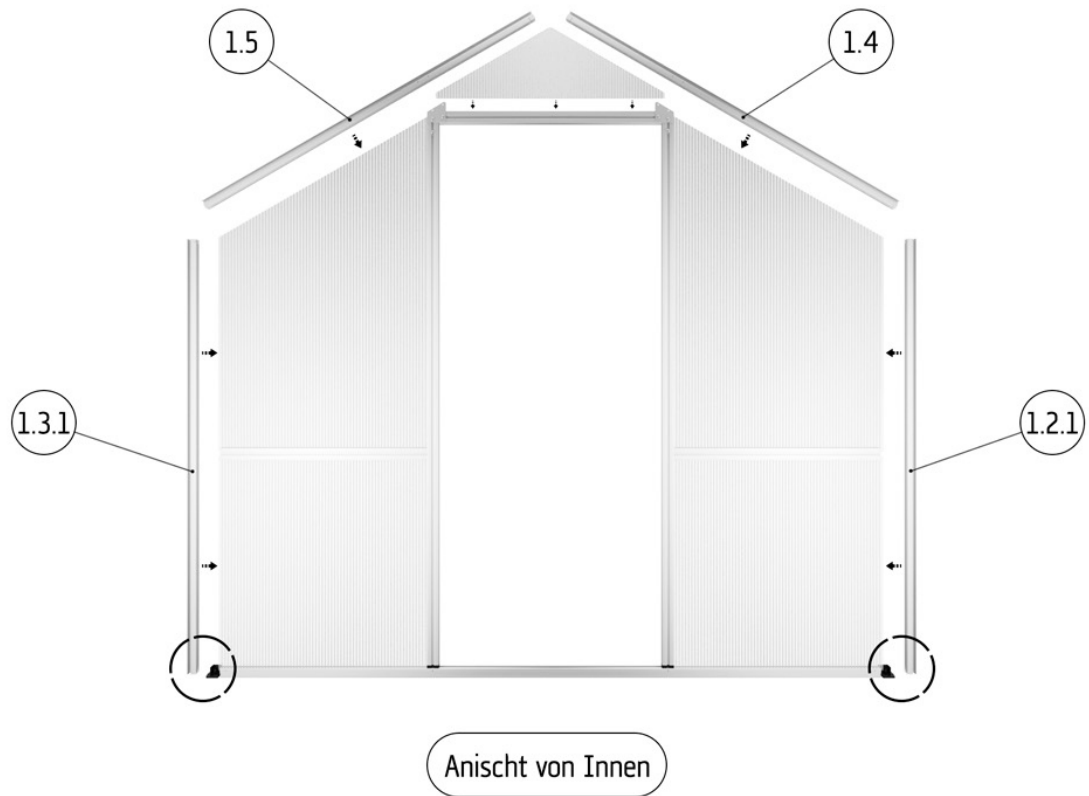

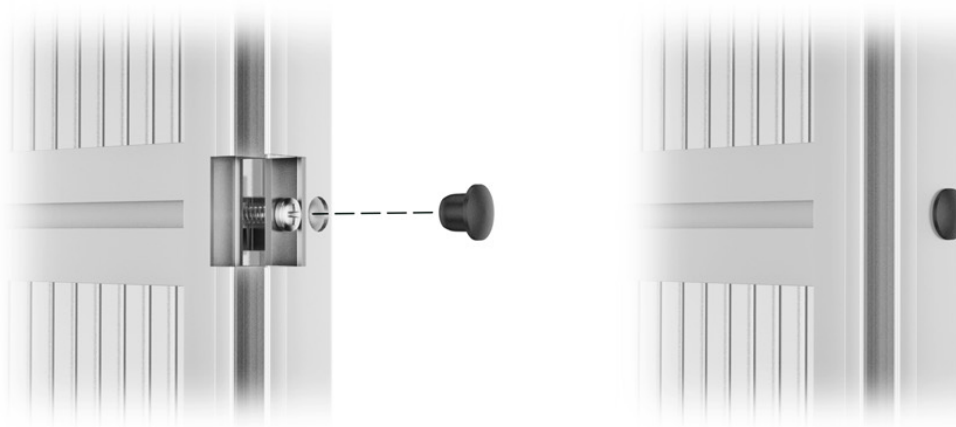
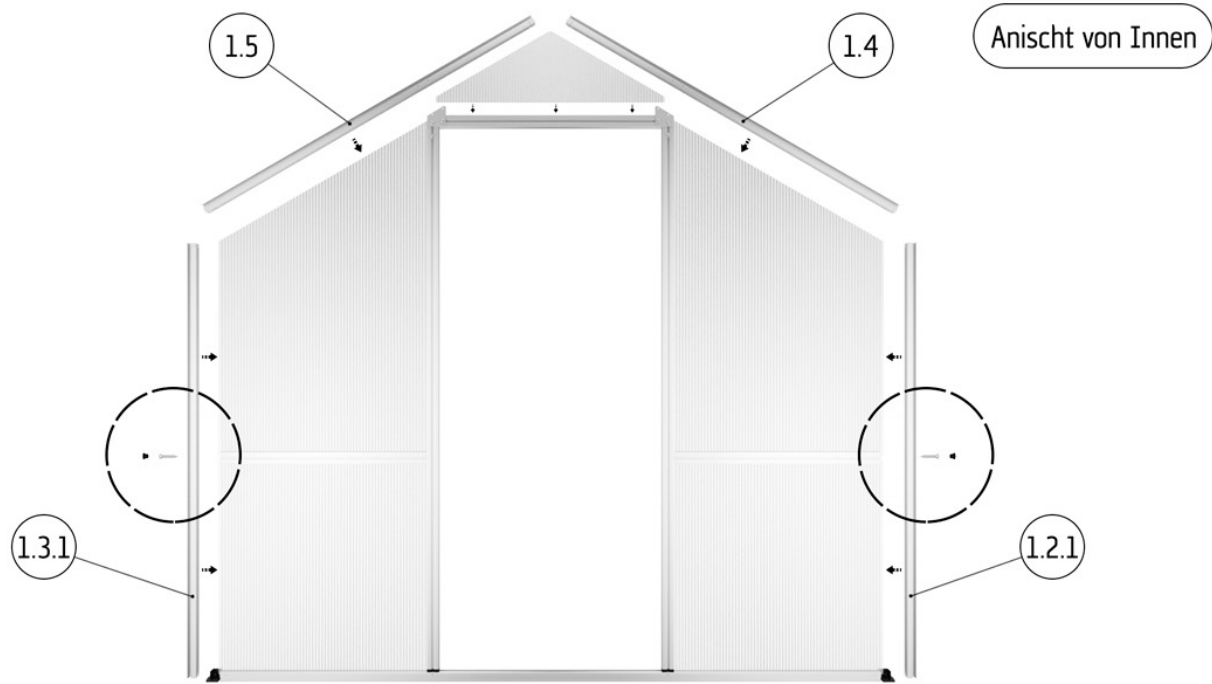

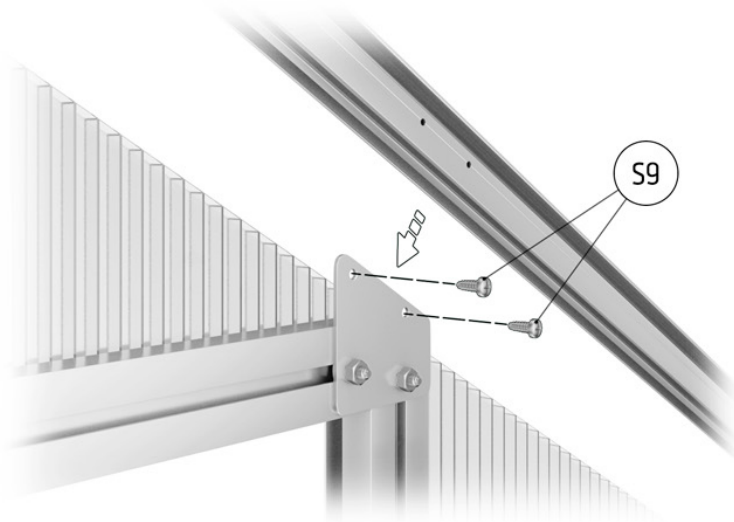
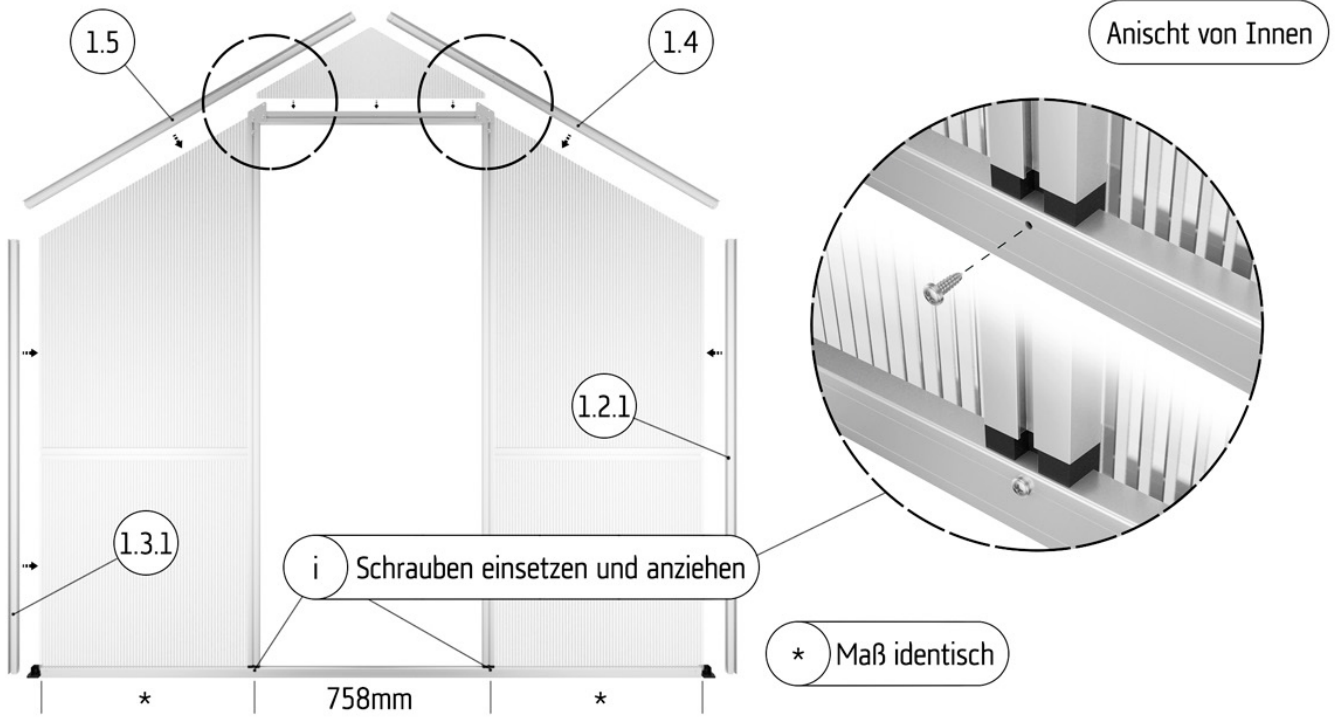

### Gründung des Gewächshauses

Hier: Standard-Variante *ohne* Fundamentrahmen aus dem Zubehör  
Der Fundamentrahmen ist separat erhältlich und gehört nicht zum Lieferumfang.

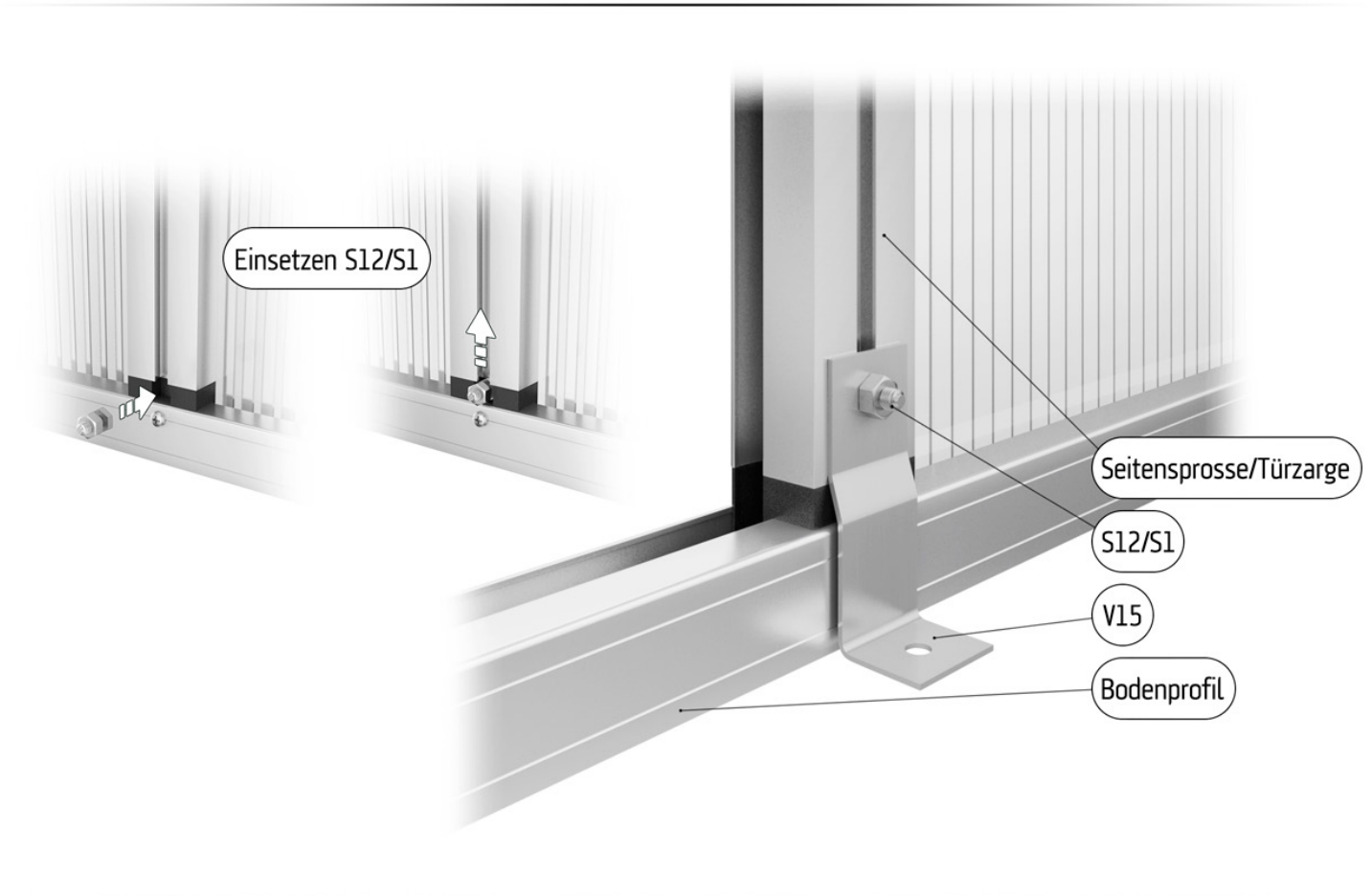

Wir empfehlen für das Aufdübeln Schlüsselschrauben inkl. Dübel zu verwenden.  
Diese sind im Lieferumfang nicht enthalten.

Anischt von Innen

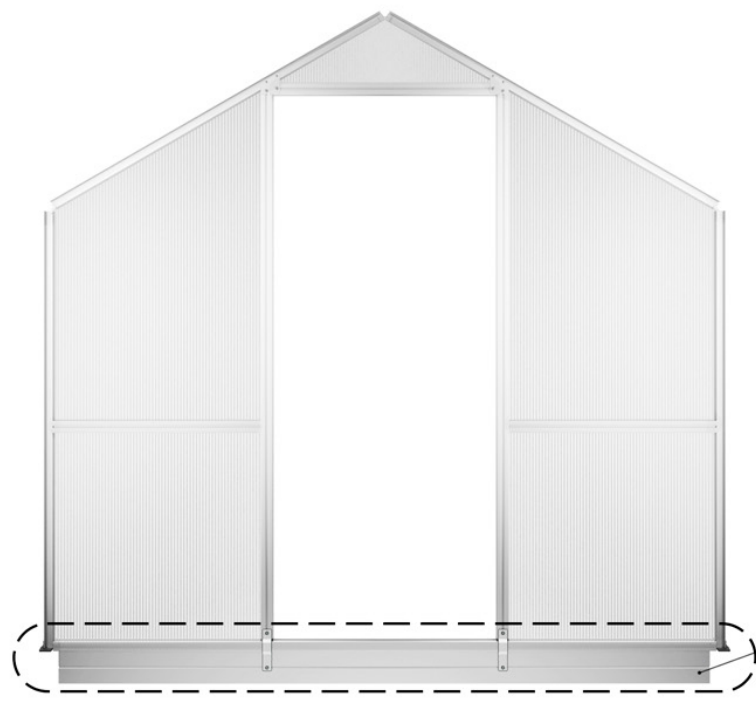

Fundamentrahmenprofil  
Zubehörartikel, Bauteil ist  
nur in Verbindung mit dem  
Modul *Fundamentrahmen*  
erhältlich und gehört  
nicht zum Lieferumfang.

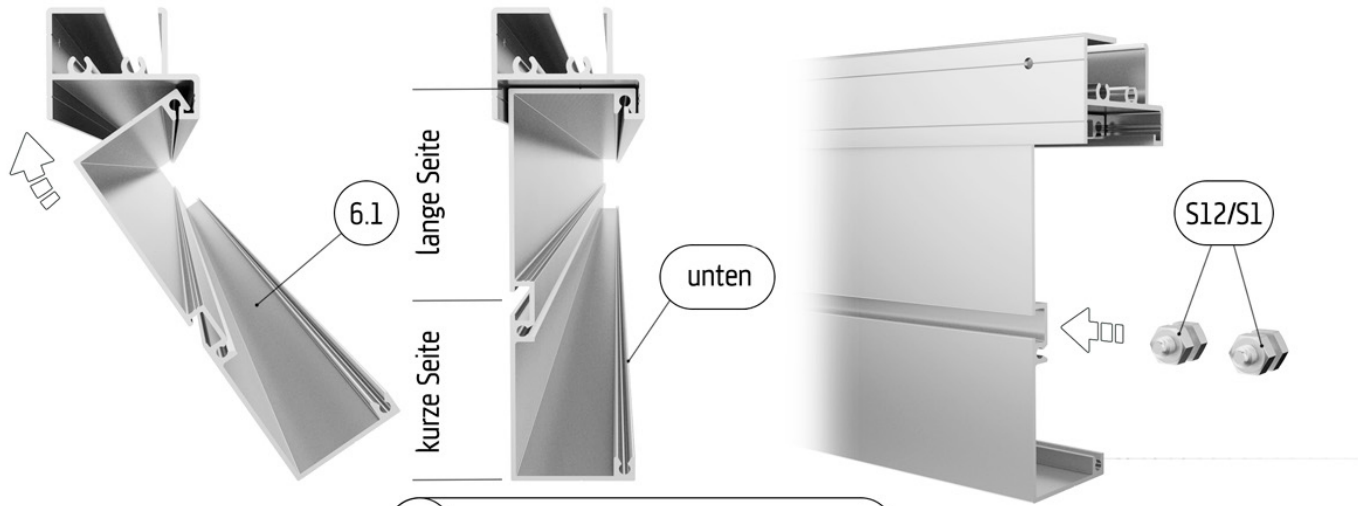

i Zubehör, Modul: Fundamentrahmen

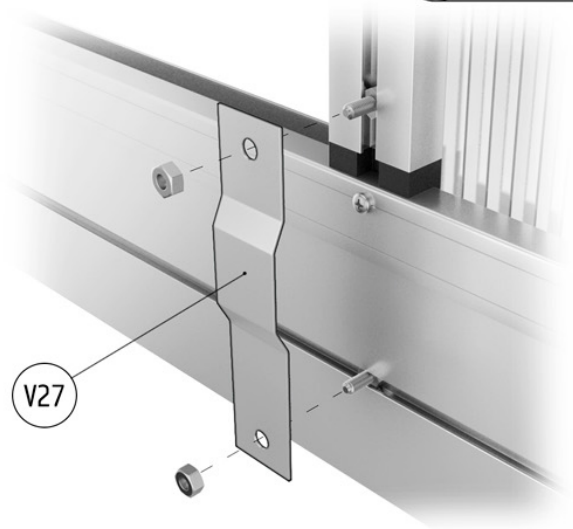



i untere Drehtür zuerst montieren

Modul: Drehtür - oben

Modul: Drehtür - unten

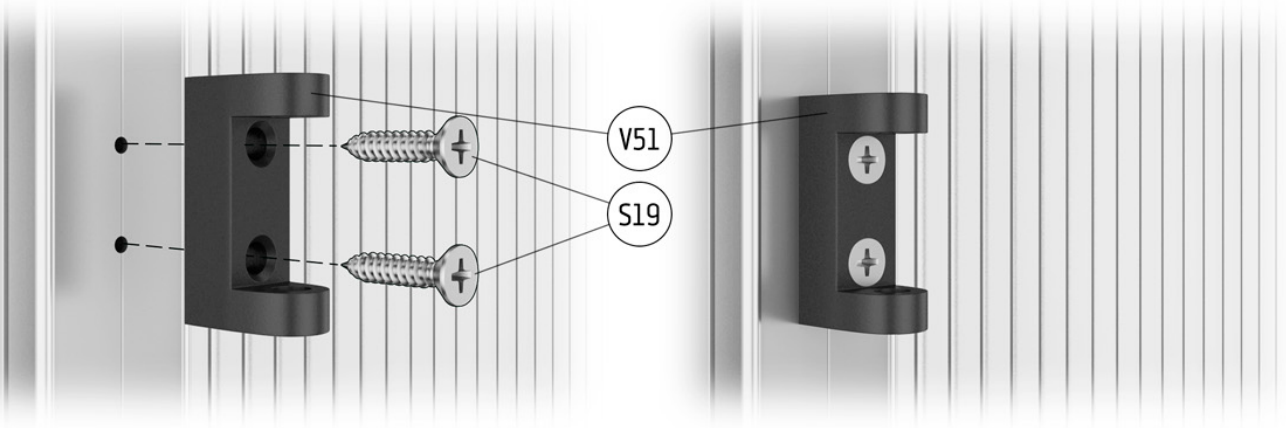

Falls noch nicht geschehen:  
jetzt einsetzen

