

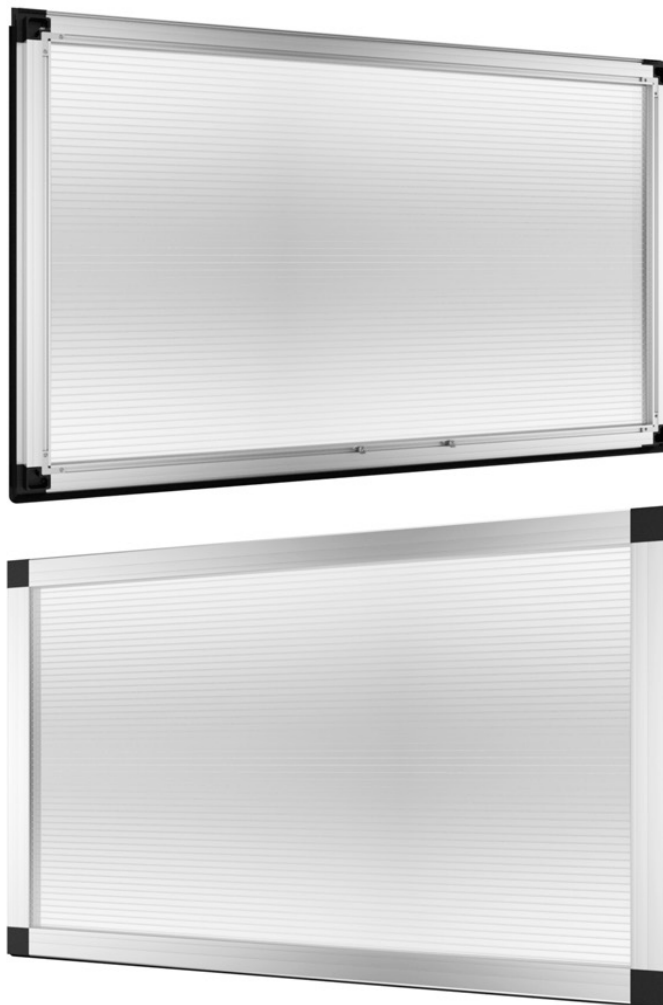

KGTT

KREATIVE GARTENTECHNIK







MODUL: DACHFENSTER



MONTAGEANLEITUNG

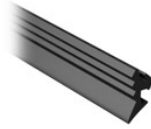

STÜCKLISTE DACHFENSTER

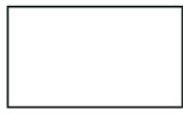
Pos.		Bezeichnung	Art.-Nr.	Anzahl	Abmessung in mm
S12 S1		Sechskantschraube M6 x 12 Mutter M6 (Montage Fensterheber)	9999 0124 9999 0128	2	
V13		Winkel mit Madenschraube	9999 0070	4	
V21		Innensechskantschlüssel	9999 0056	1	
V24		Eckverbinder/Dachfenster	9999 0005	4	
V98		Sprossendichtung 2mm	9999 0376	1	Lieferung der Dichtung erfolgt in einem ca. 15m langen Strang und wird bauseits zugeschnitten
4.1		Fensterprofil Dach		2	541
4.2		Fensterprofil Dach		2	953
		ISO Hohlkammerplatte		1 1 1 1 1	Rose II 974x565 Rose III 974x565 Rose IV 974x565 Orchidee III 974x565 Orchidee IV 974x565
		Ende der Stückliste			

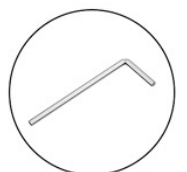
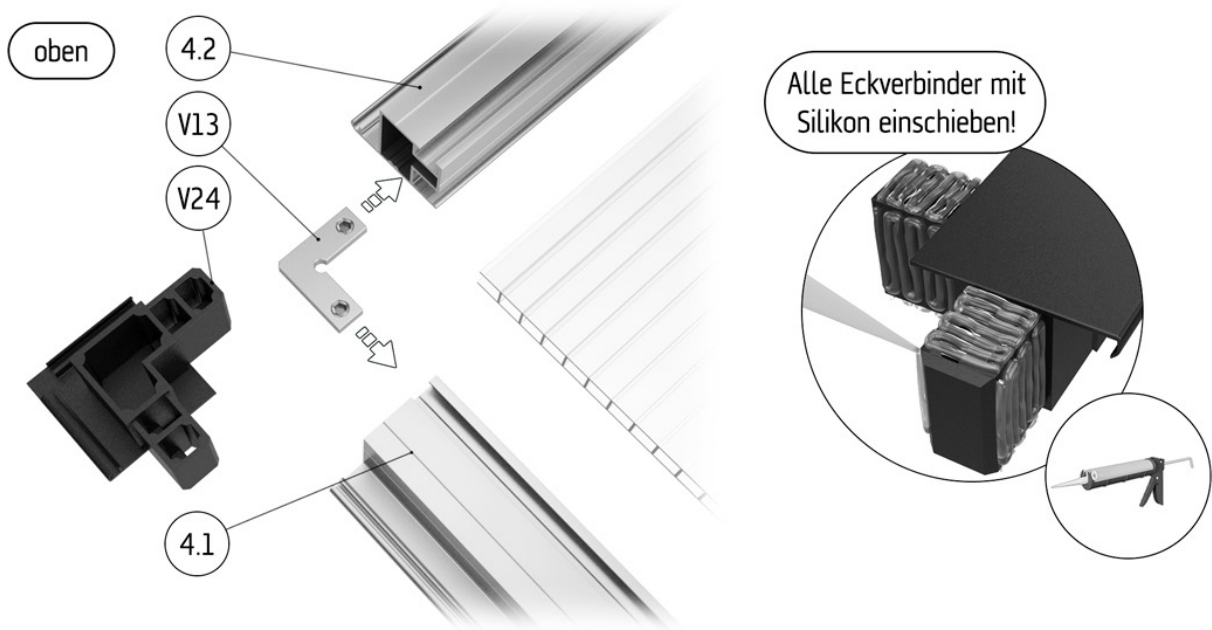
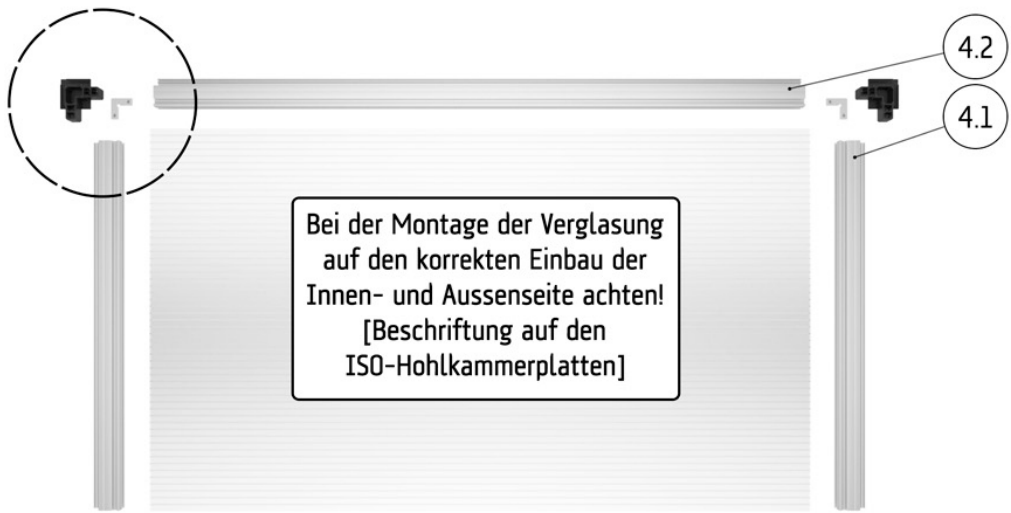

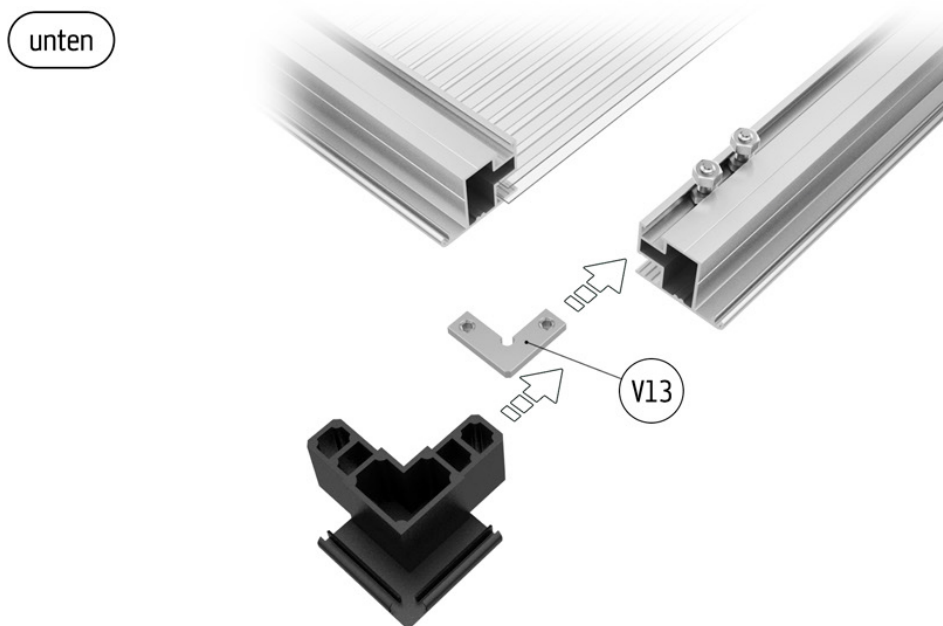
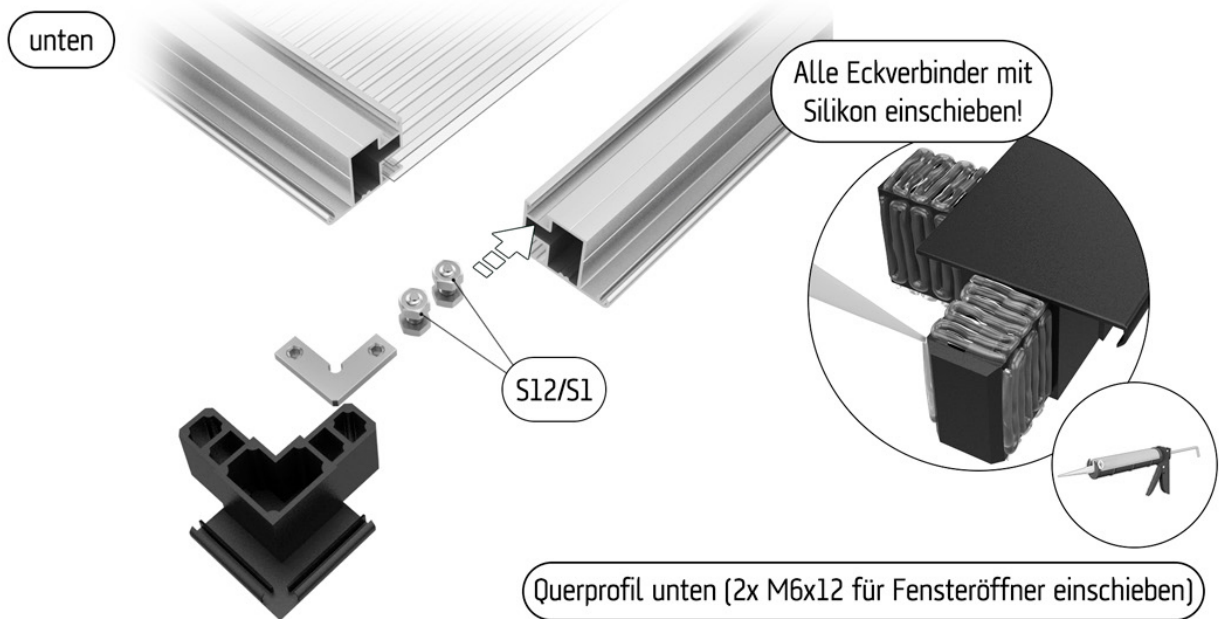
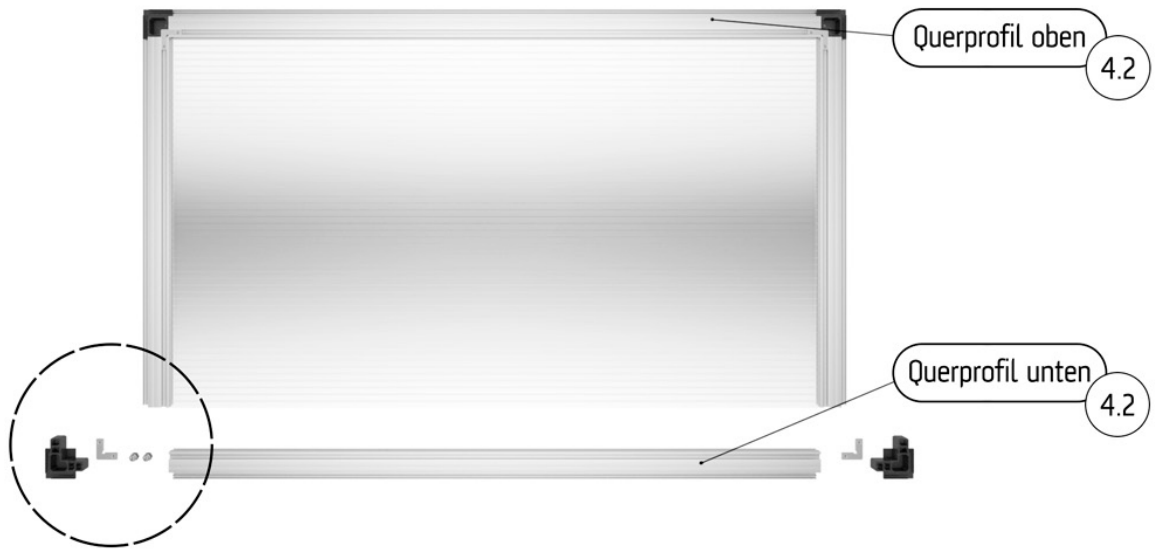

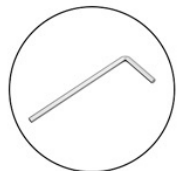
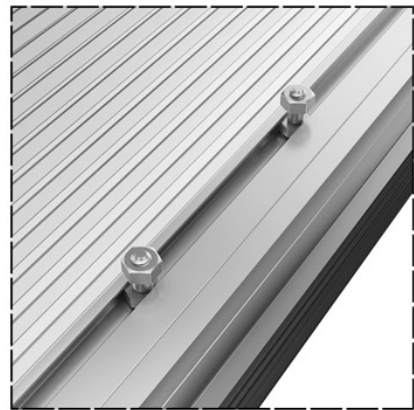
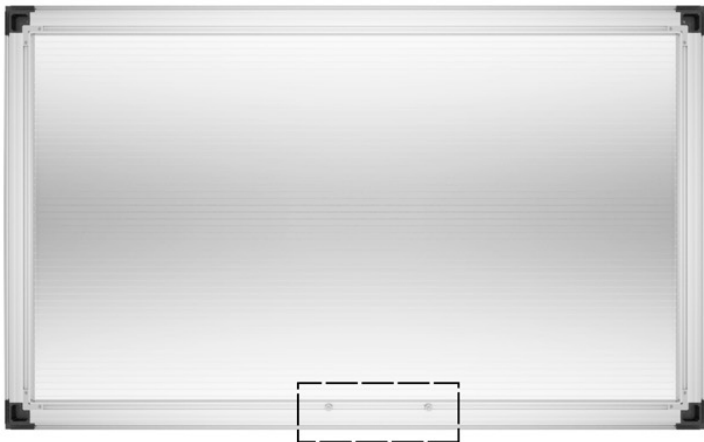
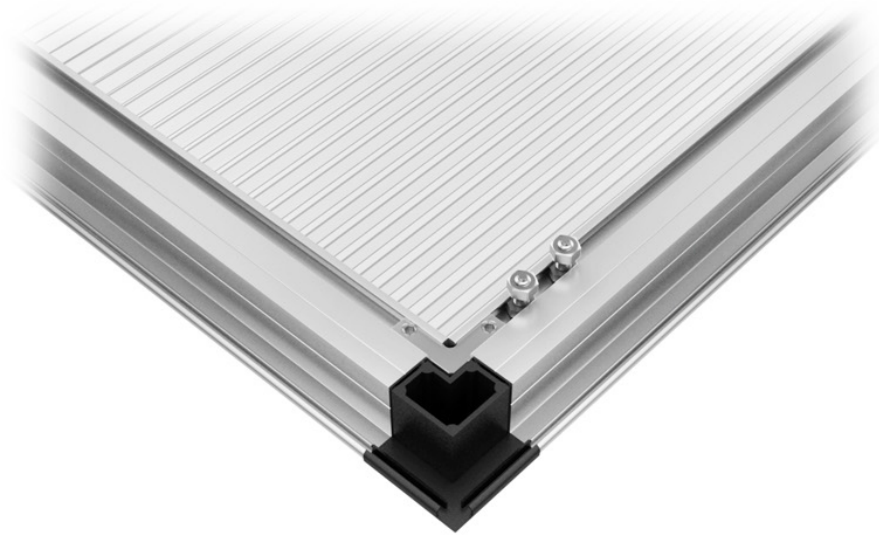

Keine Sprossendichtung in das oben liegende Profil einziehen!

Schnitt: eingezogene Dichtung

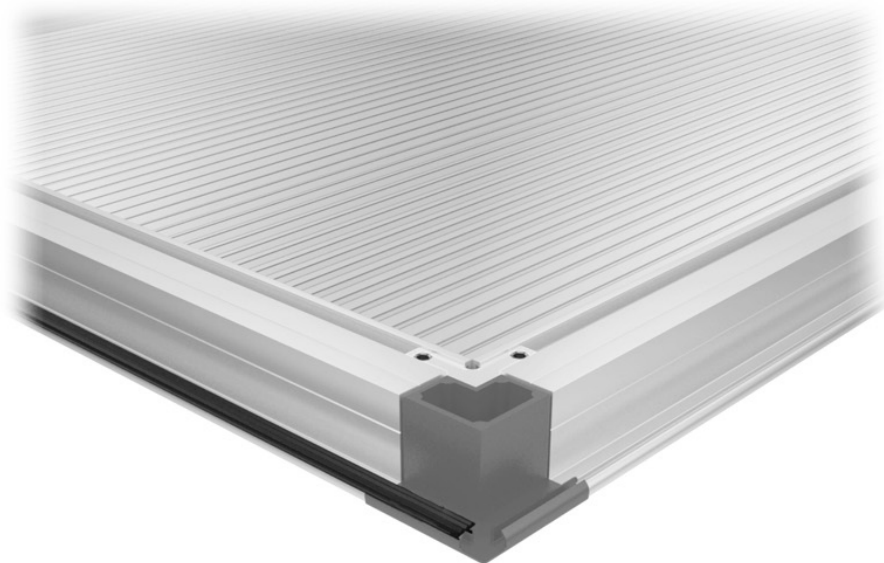
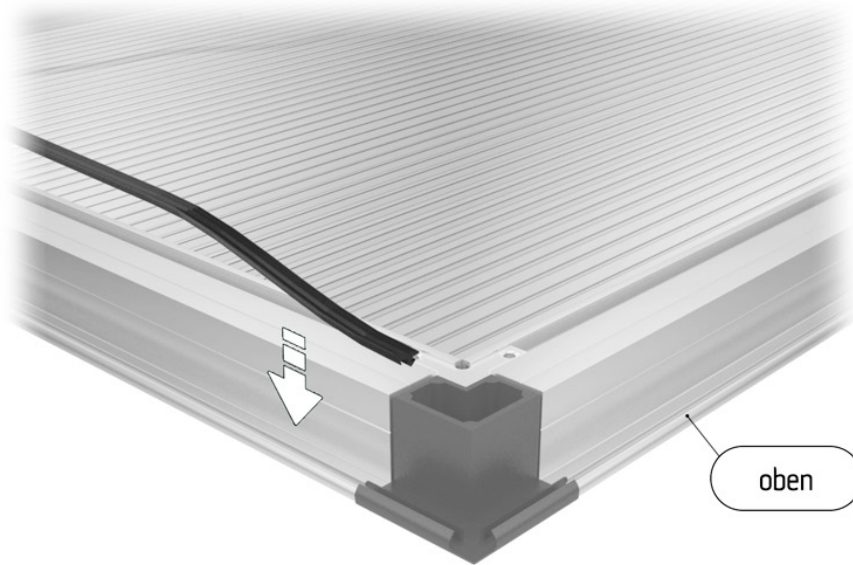
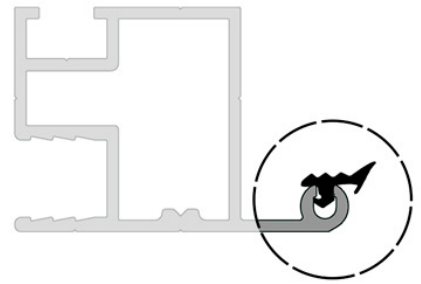
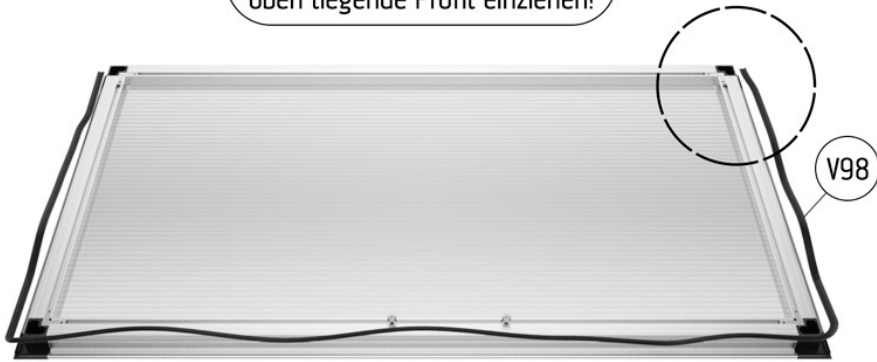

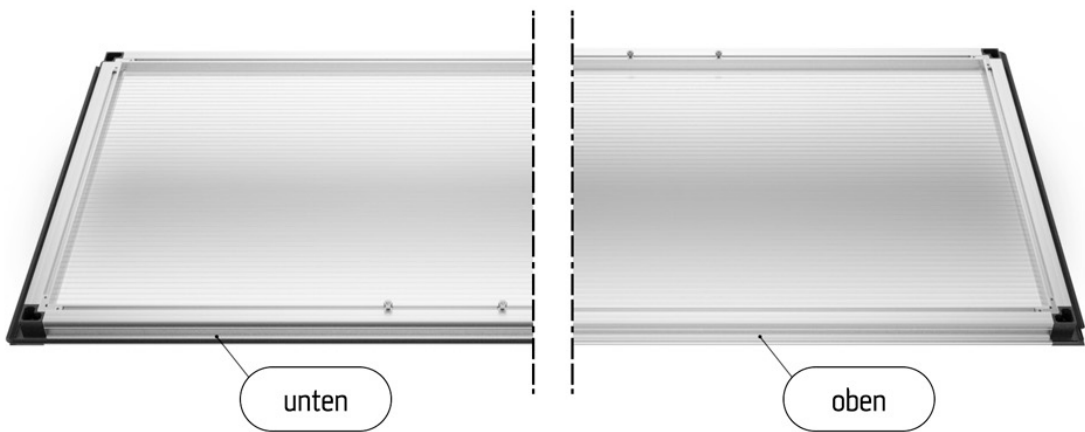
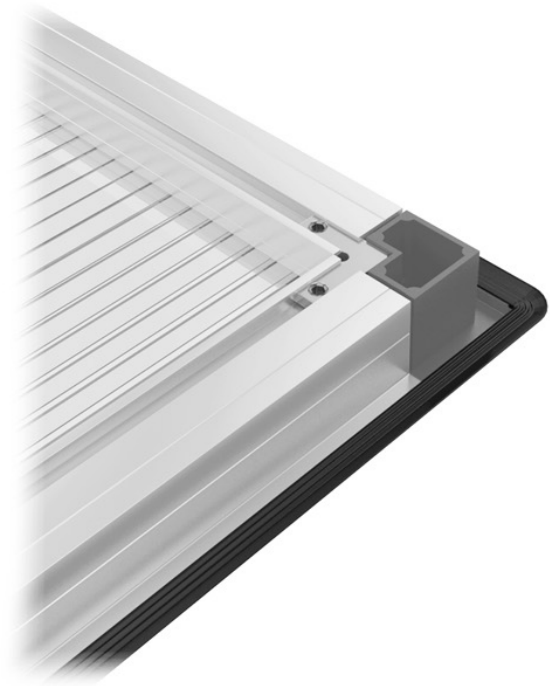
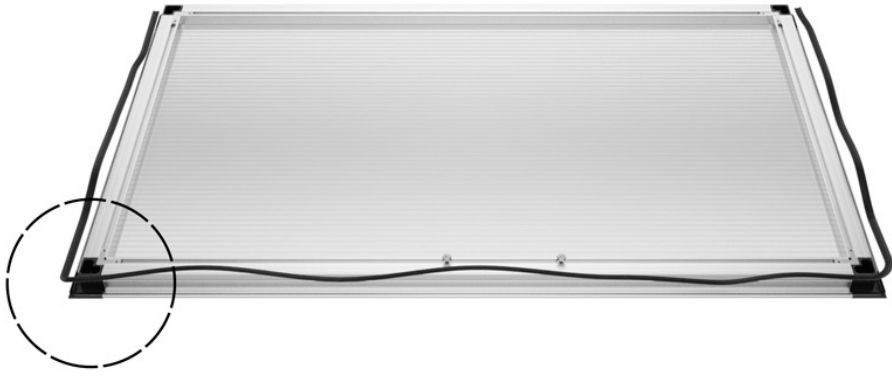

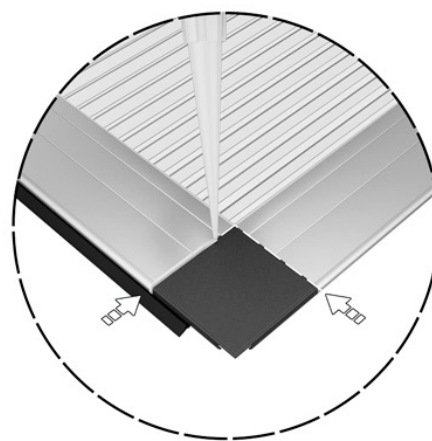
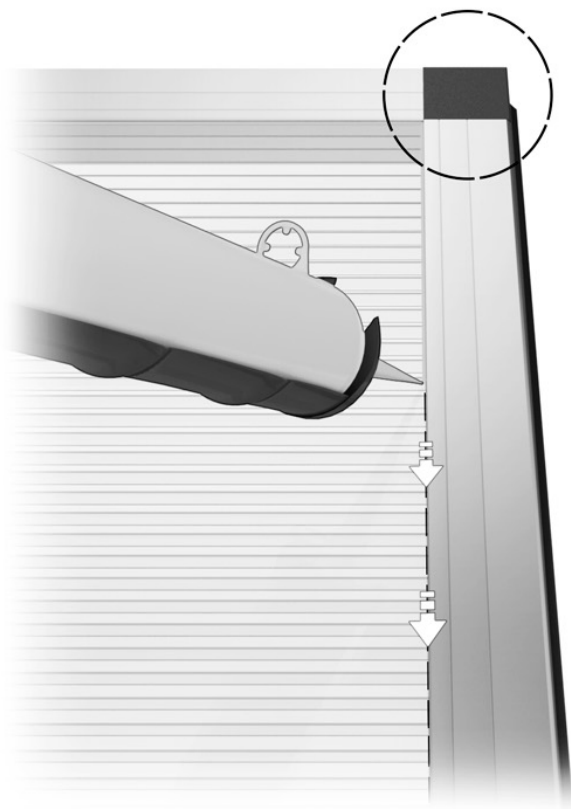

Alle Übergänge der
Eckverbinder mit Silikon
sauber versiegeln

