

	#390350	#390354
	DN 100	DN 150
Z1	185 [7.3"]	210 [8.3"]
Z2	830 [2'-8.7"]	805 [2'-7.7"]
A1	265 [10.4"]	240 [9.5"]
A2	750 [2'-5.5"]	775 [2'-6.5"]

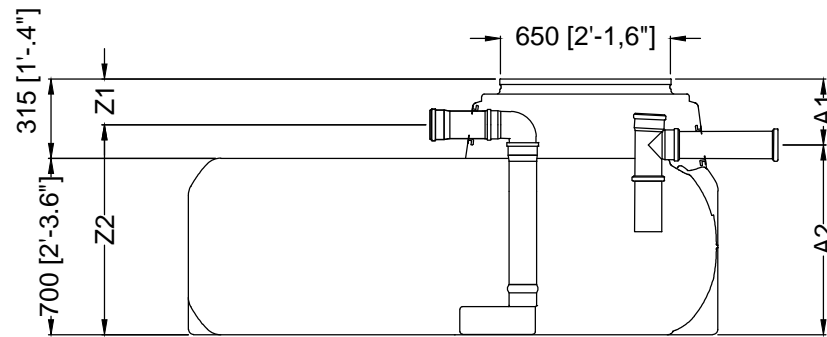

D			GRAF Platin Flachtank 1500 L / 396,3 gal. Sedimentationstank DWA-M 153		Artikel-Nr. product no. 390350 / 390354 article no. articulo no.	
GB		ES		FR		Otto Graf GmbH Carl-Zeiss-Str. 2-6 DE-79331 Teningen mail@graf.info www.graf.info
GRAF Platin flat tank 1500 L / 396,3 gal.		GRAF Platin Depósito de poco profundidad 1500 L / 396,3 gal.		GRAF Platin Cuve à enterrer 1500 L / 396,3 gal.		
gezeichnet, drawn	ISC	Gewicht, weight	82 kg	revision		
Datum, date	2017.07.12	Toleranz, tolerance	+/- 3%	Maßstab, scale	M 1:30	Einheiten, units mm [inch] gal. = US gal.

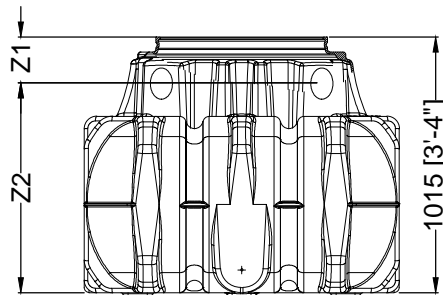
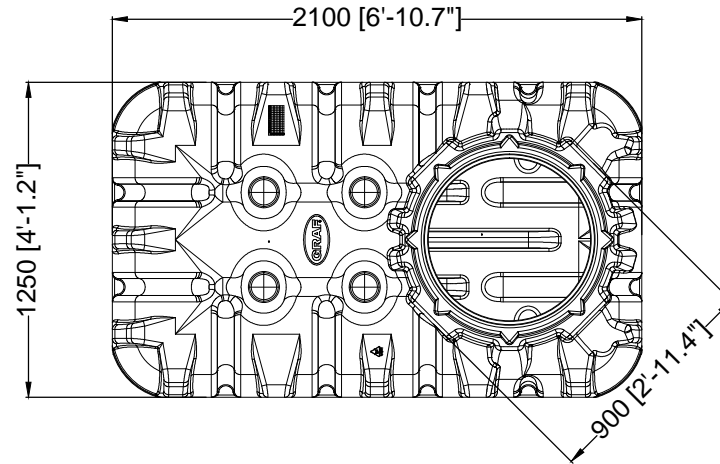